

SP6R-LSC

CONTROLLER



User Manual

DUPLEX LIFT STATION CONTROL
BAR GRAPH
4-20 MA INPUT
AUTOMATIC ALTERNATION
MOTOR STATUS LEDs



TABLE OF CONTENTS

Specifications	2
Introduction	3
Warnings	4
Installation & Dimension Data.....	5-7
Electrical Connections	8-10
Function Keys / Displays	11
Setting Up Levels and Simulation.....	11-12
Configuration.....	13-15
Configuration Mode Parameters	16
Run Mode Parameters.....	17



SPECIFICATIONS

INPUT TYPE

4-20 mA signal.

INPUT IMPEDANCE

100 ohms.

INPUT RESOLUTION

12 - bits, 0.1% of full scale.

SAMPLING CYCLE TIME

100 mS.

AVERAGING

8 consecutive samples.

ACCURACY

0.5% of full scale.

EXCITATION VOLTAGE

24 VDC, 30 mA available for loop powered transducers.

RELAY OUTPUTS

Four programmable relay outputs with LED indication. "Form C" (SPDT) contacts: rated at 10A at 240 VAC.

LEVEL DISPLAY

Eight character alpha-numeric LED for process value and program parameters.

POWER

24 VDC (+/- 10%). 200 mA nominal, 400 mA max.

OPERATING TEMPERATURE

-15°C to 70°C (0°F to 150°F) at up to 0-90% RH non-condensing.

ENCLOSURE RATING

Front Panel: IEC Standard IP54 (with additional gasket) for indoor use.

Rear Case: IEC Standard IP20.

BAR GRAPH

20 segment bar graph display for process value. Each bar represents 5% of full scale.

SP6R-LSC LEVEL CONTROLLER INTRODUCTION



The **SP6R-LSC Duplex Lift Station Controller** monitors the level in the wet well and controls the operation of one or two pumps.

In addition, it also monitors the pump run, pump seal failure and pump over temperature status. The controller has a built in alternator, run time meters, cycle counters and a level simulator. Level can be monitored via a submersible transducer or any other 4-20 mA device. The controller can be configured for pump down or pump up applications.

The **standard SP6R-LSC** lift station controller kit contains (see **Figure 2** on **page 5** of this manual):

- one SP6R-LSC lift station controller
- two mounting brackets for panel mounting
- a two pin power supply connector block
- a five pin transducer connector block
- two 6 pin relay output connector blocks
- a 12 pin pump status input connector block

The **SP6R-LSC-N4X** version includes a controller mounted in a **NEMA 4X** enclosure. These units are ideal for replacing float switch or “bubbler” control systems.

Failure to read and understand the information provided in this manual may result in personal injury or death, damage to the product or product failure. Please read each section in its entirety and be sure you understand the information provided in the section and related sections before attempting any of the procedures or operations given.

Failure to follow these precautions could result in serious injury or death. Keep these instructions with warranty after installation. This product must be installed in accordance with National Electrical Code, ANSI/NFPA 70 so as to prevent moisture from entering or accumulating within the controller housing. **See additional specifications on page 14 of this manual.**

! WARNING



ELECTRICAL SHOCK HAZARD

Disconnect power before installing or servicing this product.

A qualified service person must install and service this product according to applicable electrical codes.

- Do not install in area with: excessive or conductive dust, corrosive or flammable gas, moisture or rain, excessive heat, regular impact shocks or excessive vibration.
- Do not place in water or let water leak onto the controller.
- Do not allow debris to fall inside the unit during installation.
- Double-check all the wiring before turning on the power supply.
- Do not touch live wires.
- Stay as far as possible from high-voltage cables and power equipment.
- Leave a minimum of 10 mm space for ventilation between the top and bottom edges of the controller and enclosure walls.

! WARNING



EXPLOSION OR FIRE HAZARD

Do not use this product with flammable liquids. Do not install in hazardous locations as defined by National Electrical Code, ANSI/NFPA 70.

INSTALLATION & DIMENSIONAL DATA

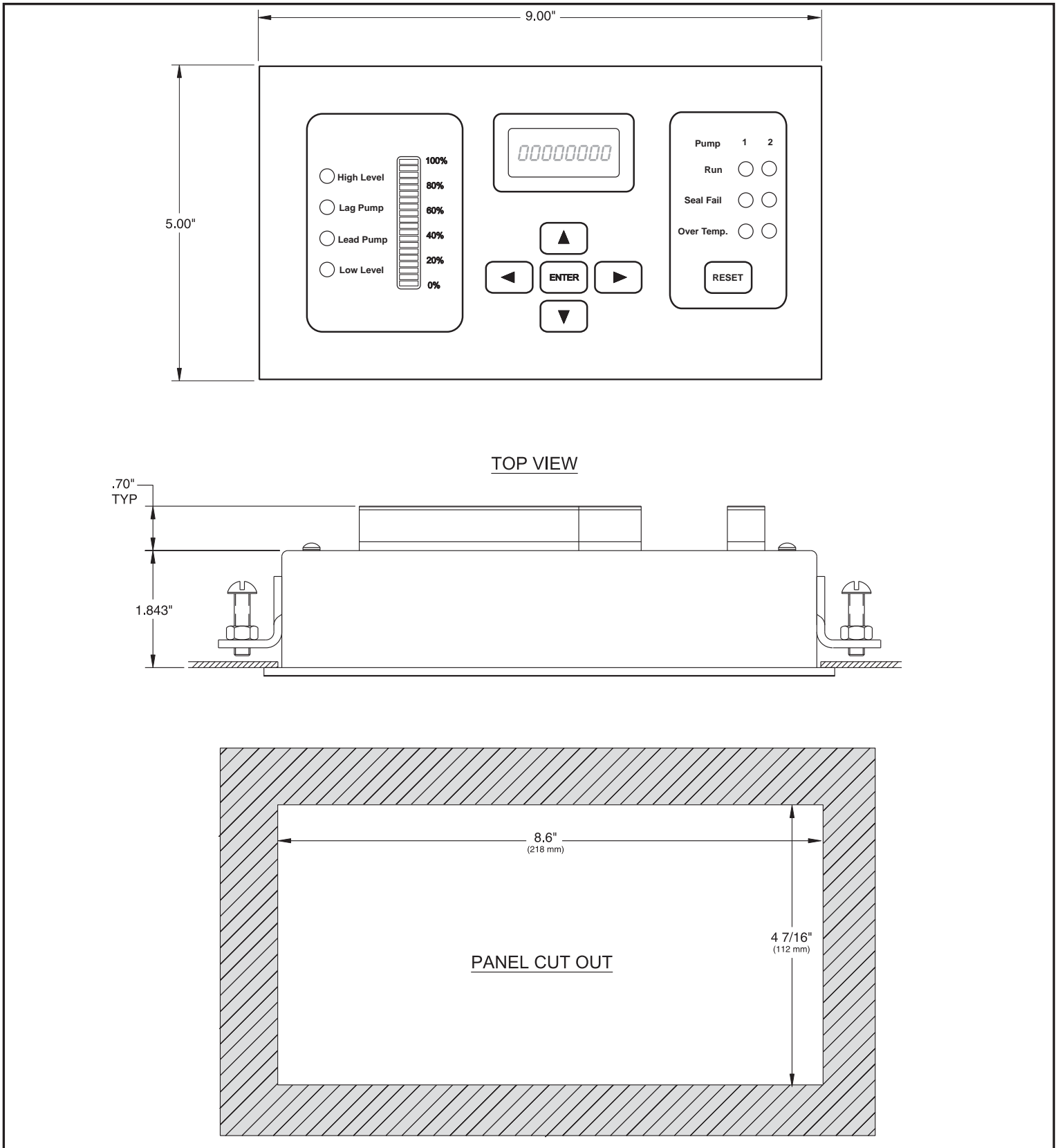
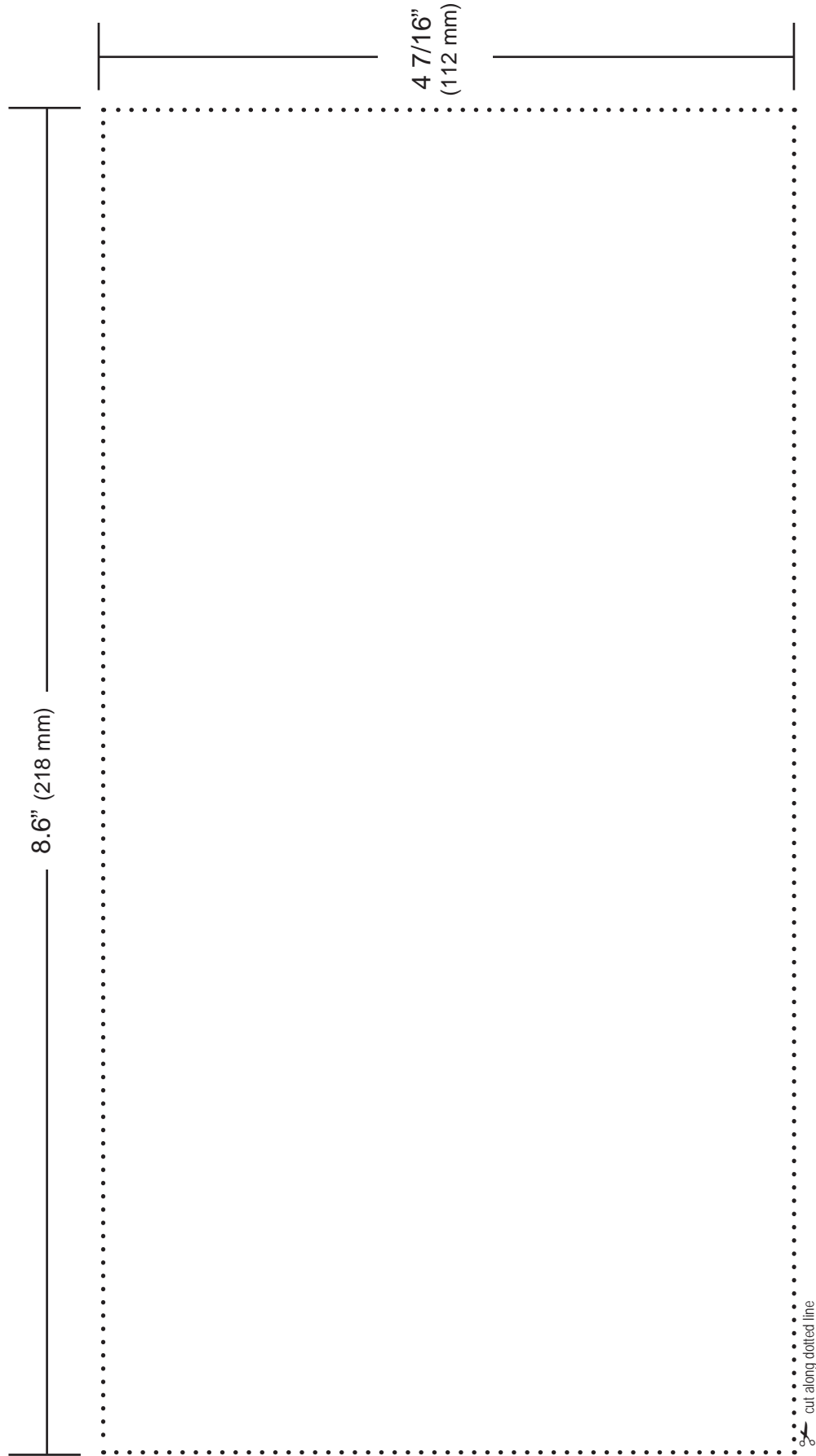

FIGURE 1 Dimensions and panel cut-out. Dimensions are indicative and may be subject to change without notification.

PANEL CUT OUT TEMPLATE FOR SP6R-LSC LIFT STATION CONTROLLER



INSTALLATION & DIMENSIONAL DATA

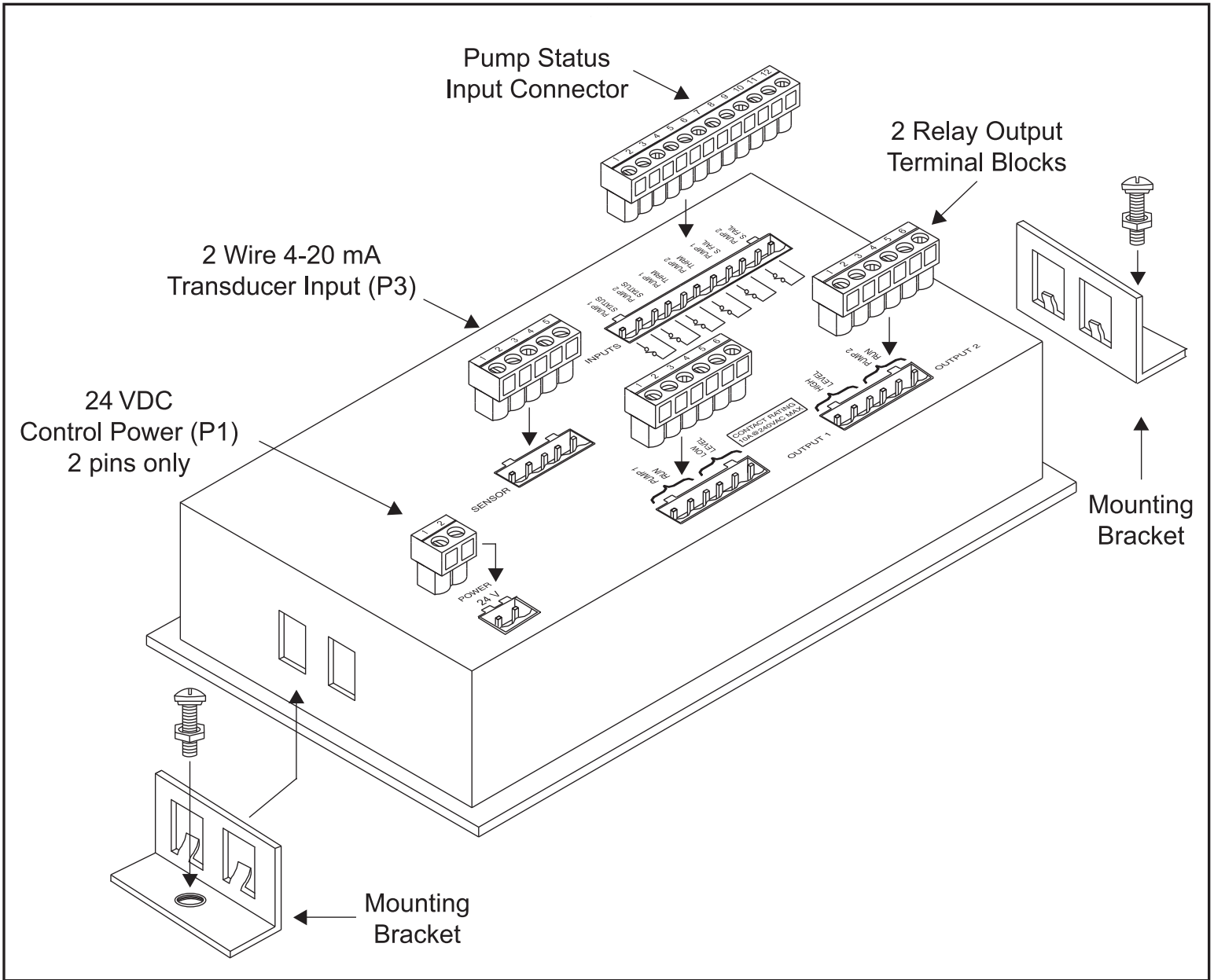

FIGURE 2 Standard SP6R-LSC duplex lift station controller kit.

ELECTRICAL CONNECTION

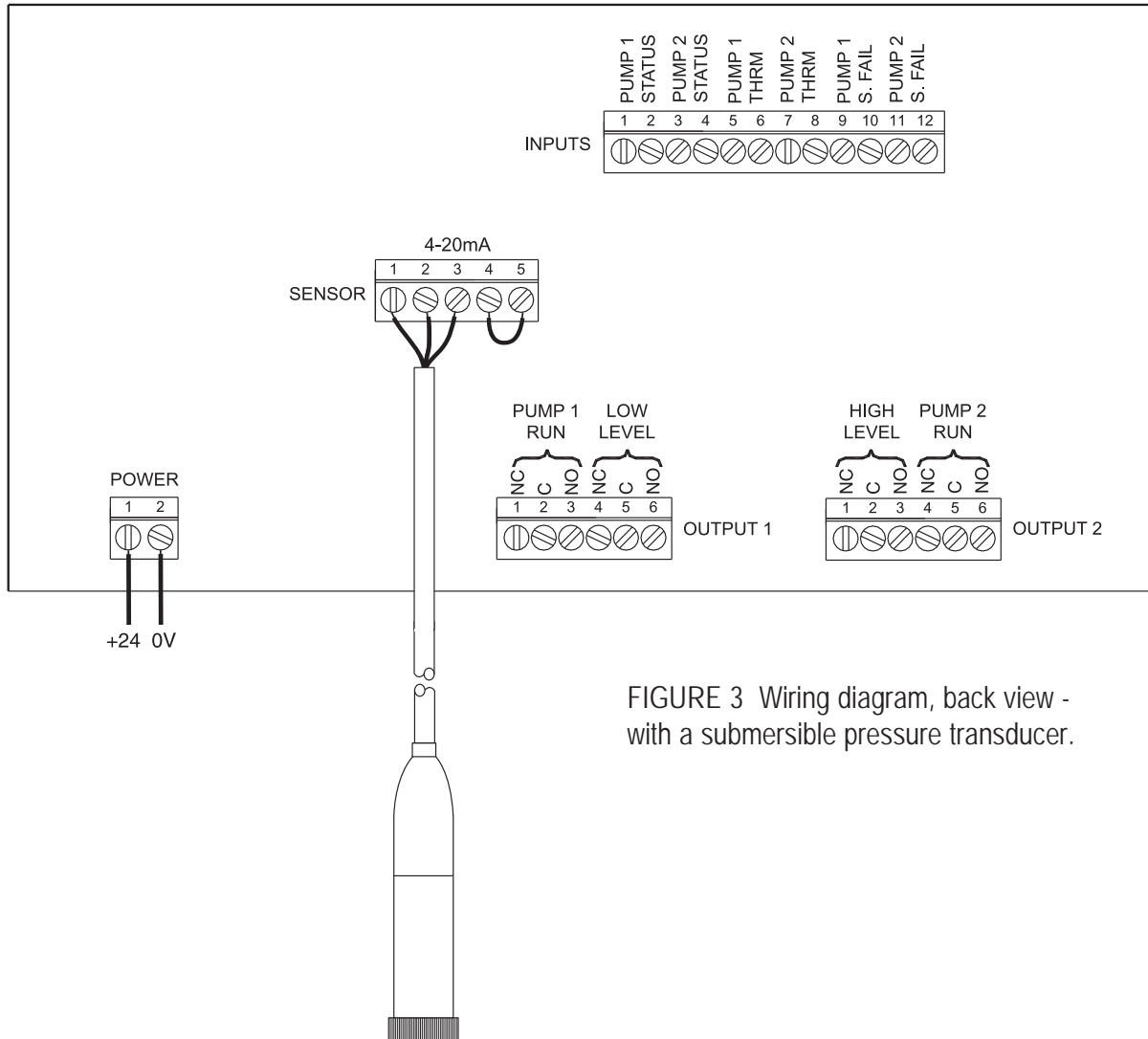

FIGURE 3 Wiring diagram, back view - with a submersible pressure transducer.

1. POWER

Connect power to terminal 1 and 2: the unit requires 24 VDC (+/- 10%).

2. SENSOR

LOOP POWERED TRANSDUCER

For loop powered transducers (2 wire) connect power conductor to terminal 1 and 2. If the cable is protected with an overall shield, connect the shield to terminal (3). Terminal 4 and 5 must be connected if an output follower is not required. If no valid input is present, the controller will flash “**SENSOR**” and all outputs will be de-energized, except the high level alarm.

SELF POWERED SIGNAL TRANSDUCER

Connect to terminal 2 and 4 and shield to terminal 3.

NOTE: To avoid ground loops, the shield of the signal cable must only be grounded at one end.

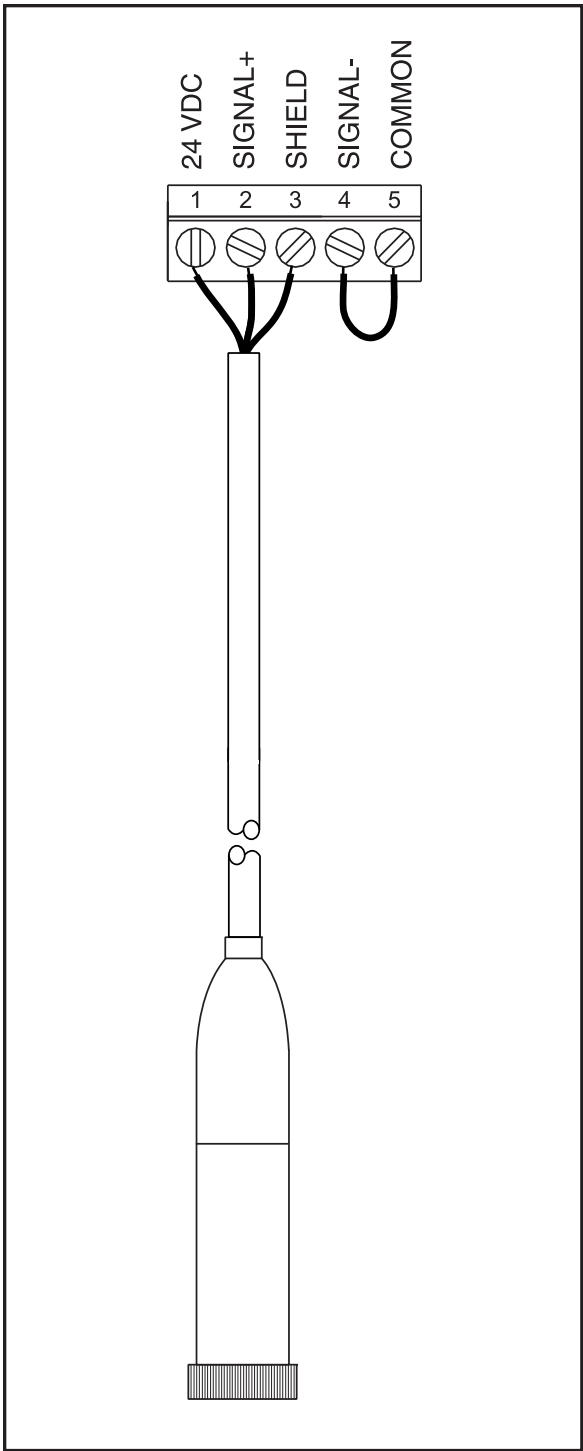

FIGURE 6 Loop Powered Transducer Connection.

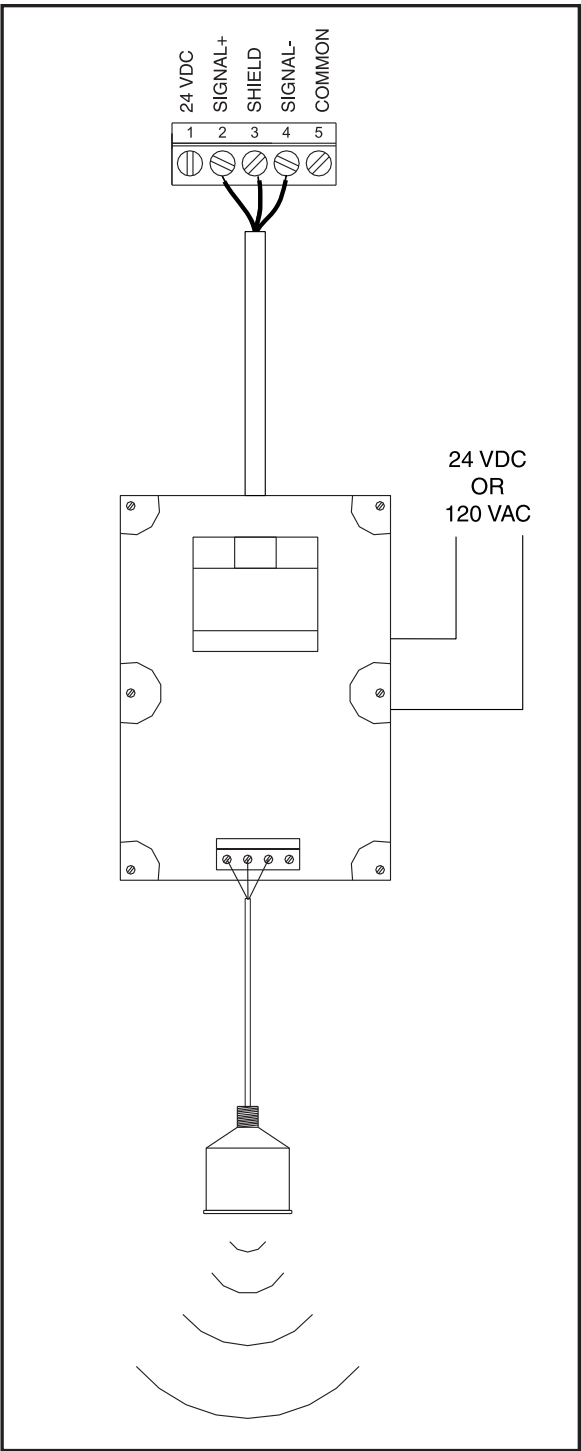

FIGURE 7 Self Powered Signal Connection.

4. PUMP STATUS CONNECTIONS

Dry contacts: use potential free contacts only for pump status inputs.

WARNING

Equipment damage will result if any voltage is connected to the input terminals.

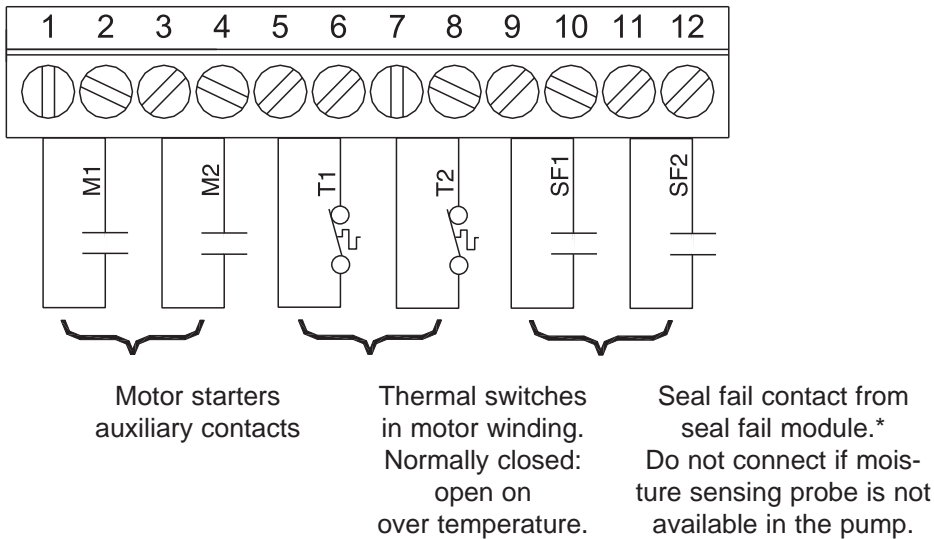

FIGURE 4 Pump Status connections.

*Seal fail module must be approved by pump manufacturer.

5. OUTPUT RELAY CONNECTIONS

The relay outputs are rated up to 10 A (resistive) at 240 VAC, fuse protection is required individually or as a group.

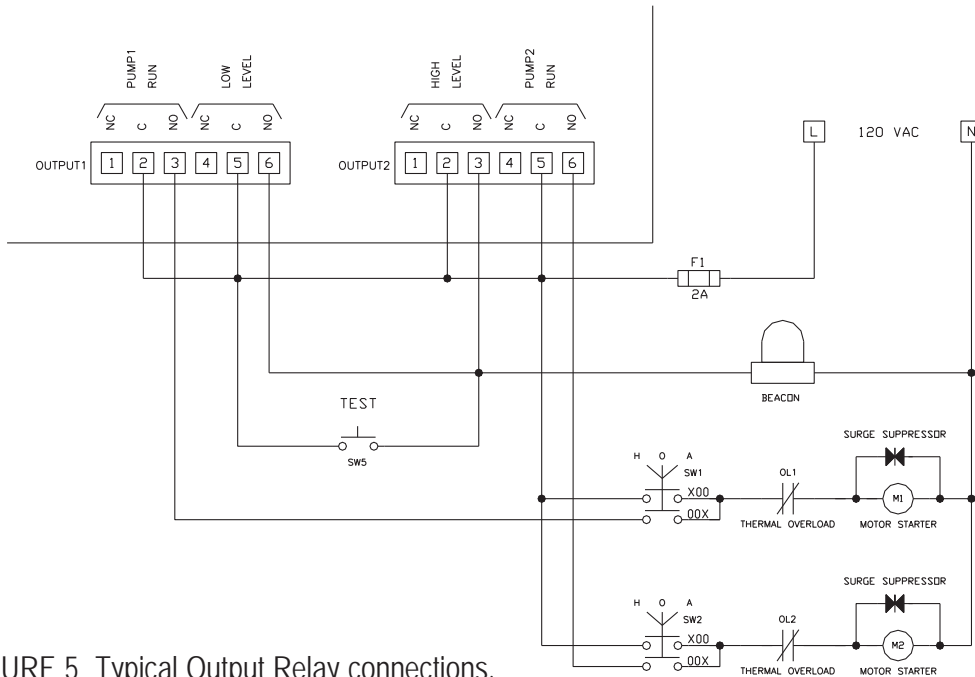
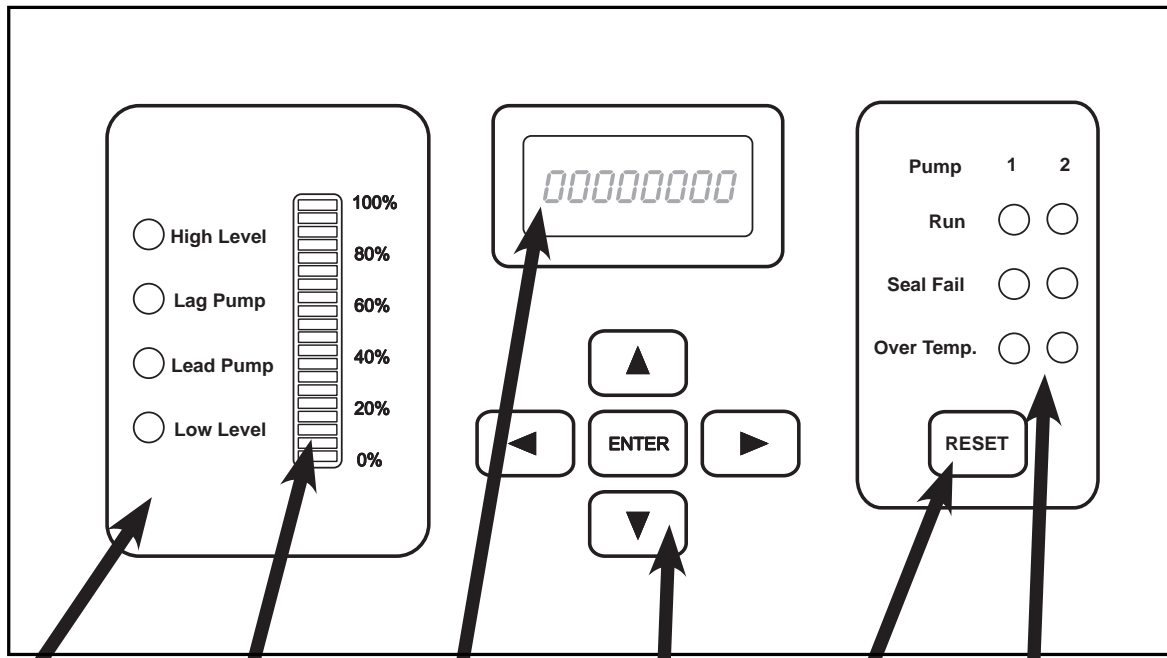

FIGURE 5 Typical Output Relay connections.

FUNCTION KEYS / DISPLAYS



LEVEL STATUS
4 LEDs indicating low level alarm, high level alarm and lead/lag pump called to run.

BAR GRAPH
20 segment bar graph display for process value. Each bar represents 5% of full scale.

LEVEL DISPLAY
Eight character alpha-numeric LED for process value display and program parameters.

KEYPAD
Arrow keys are used to navigate through the configuration for adjusting set points.

RESET
Alarms can be configured to latch until the fault reset button is pressed.

PUMP STATUS DISPLAY
Indicators for each pump: run, seal fail and over temperature indicators.



LEFT AND RIGHT ARROW KEYS are used to navigate through the menu items. These arrow keys can also be used to back out when in editing and simulation mode.



ENTER KEY is used for selecting a menu item for editing. This key is also used after a value has been edited to store in memory.



UP AND DOWN ARROW KEYS are used to increase or decrease the current value being edited.



RESET BUTTON is used to clear pump faults that are no longer active.

NOTE: The display automatically returns to “level” after 20 seconds of inactivity, regardless of where it was left.

Pressing once will increment the current value by **one** unit. Pressing and holding will begin repeatedly incrementing after a short delay. If the operator continues to hold the key, the value continues to increment at a faster rate.

SETTING UP LEVELS

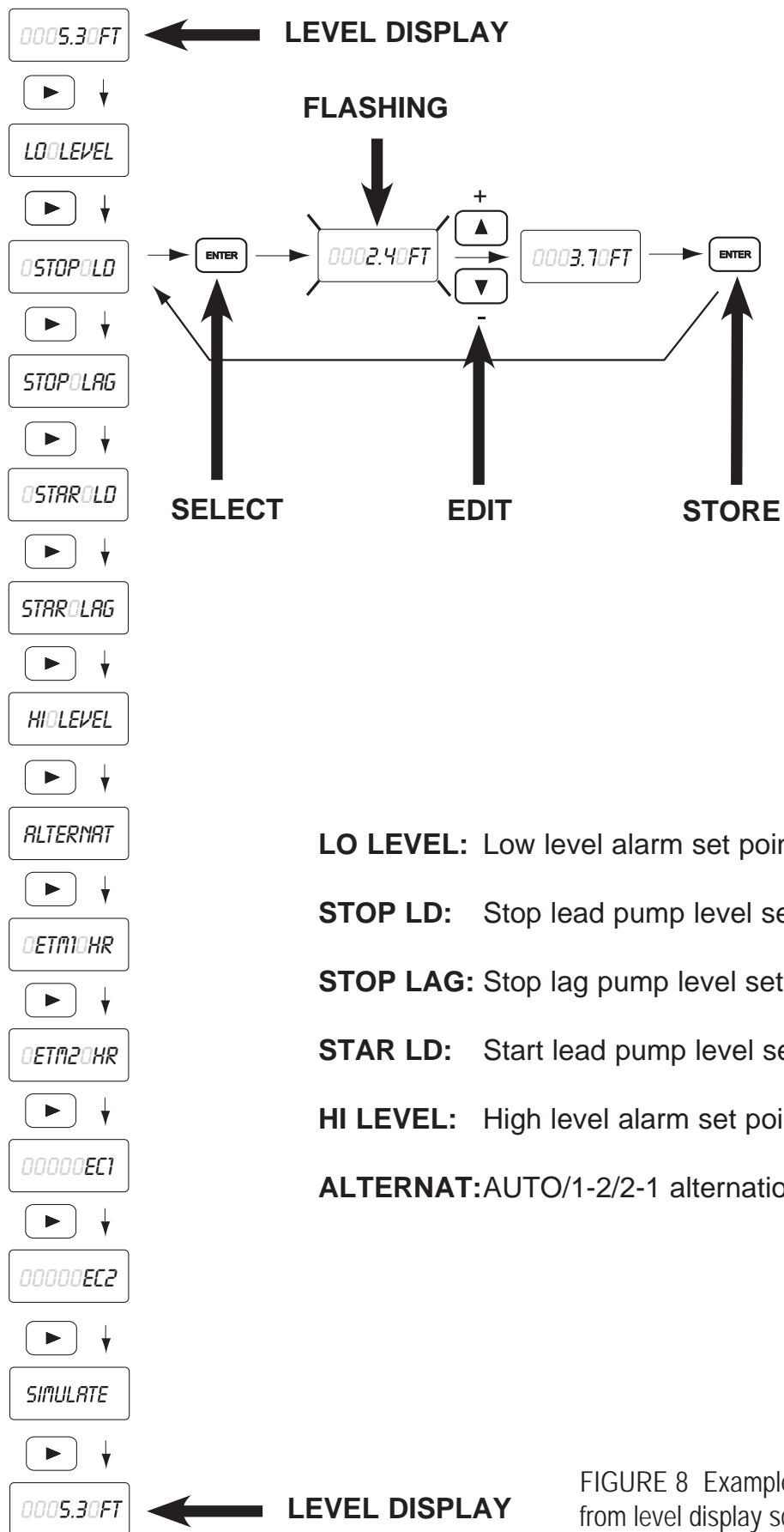

LO LEVEL: Low level alarm set point

STOP LD: Stop lead pump level set point

STOP LAG: Stop lag pump level set point

STAR LD: Start lead pump level set point

HI LEVEL: High level alarm set point

ALTERNAT: AUTO/1-2/2-1 alternation selector

FIGURE 8 Example of how to move from level display screen.

CONFIGURATION

To enter the configuration mode, simultaneously press the **LEFT and RIGHT** arrow key and hold for three (3) seconds with the unit powered **ON**.

NOTE: Eight (8) seconds of inactivity (no keys pressed) will terminate the configuration menu and exit back to the run menu.

The first item in the configuration menu is the **UNITS** selection. Use the **LEFT or RIGHT** arrow keys to navigate through all the items in this menu.

UNITS Select the unit of measure display after the process value.
FT = Feet
IN = Inches
CM = Centimeters
M = Meters
% = Percentage
NONE = Blank, No Units Displayed

When you are at the item you wish to edit, press the **ENTER** key and the original value for the item selected will flash. Use the **UP and DOWN** arrow keys to change to your desired value and press **ENTER**.

NOTE: The edited value will not be saved until the **ENTER** key is pressed.

4 mA Set the value displayed when the signal value is equal to 4mA (zero). The default value is zero.

20 mA Set the value displayed when the signal value is equal to 20mA (span). The default value is 10.0.

BAR MIN This value set the level for which all bars on the bar graph will turn OFF.

BAR MAX This value set the level for which all bars on the bar graph will turn ON.

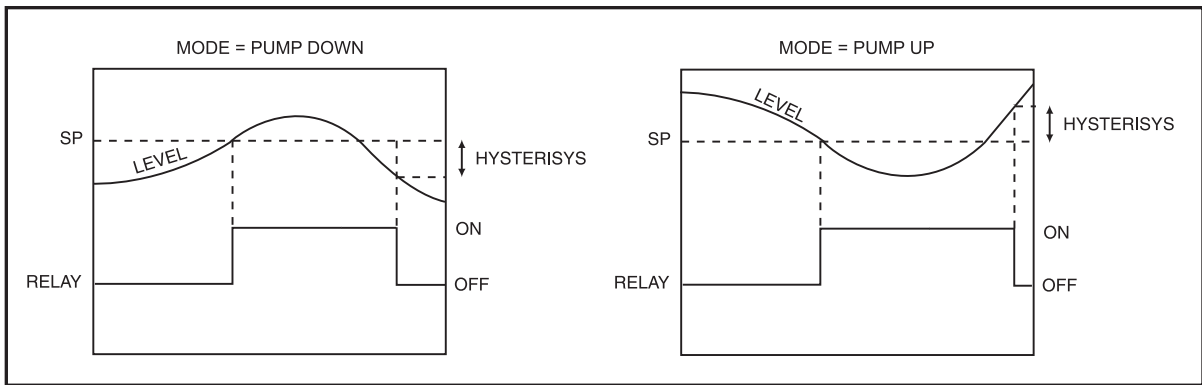

FIGURE 5

HYSTER. (hysteresis) This value will maintain the output on until the process value falls under the set point - hysteresis value.

OFFSET An offset value can be added or subtracted to bring the display value to zero at atmospheric pressure. If you are using a submersible pressure transducer, the level readout at atmospheric pressure (out of the wet well) should be zero. If it is not, add or subtract (negative) a value to bring the display to zero. Check the level readout to verify if it is zero. If not, try to change the offset again.

LAG TMR Delay timer before starting lag pump. Set from one second to 600 seconds.

SEAL FLT LED ONLY / LOCKOUT / LAG ONLY

LED ONLY: In the event of a seal failure, the pump will still be allowed to run and the seal fail light will turn on.

LOCK OUT: Pump will not be allowed to run and light will turn on.

LAG ONLY: Pump with a seal fail is only allowed to run in a lag situation. Seal fail light will turn on.

THERMAL AUTO RST / MANUAL

AUTO RST: The pump will shut down on over temperature, but will be allowed to run again if the pump cools down and the fault clears.

MANUAL: The pump will shut down on over temperature and will not be allowed to run until the fault clears and the RESET button is pressed by the operator.

HI ALARM**AUTO RST / MANUAL**

AUTO RST: The high level alarm is automatically cleared as the level drops below the HI ALARM set point.

MANUAL: The alarm will remain on until the RESET button is pressed by the operator.

LO ALARM**AUTO RST / MANUAL**

AUTO RST: The low level alarm is automatically cleared as the level rises above the LO ALARM set point.

MANUAL: The alarm will remain on until the RESET button is pressed by the operator.

MODE In **PUMP ▼** mode, as the level value rises above a set point, the controller will switch **ON** the corresponding output relay and it will remain **ON** until the level drops below the set point (the **PUMP ▼** mode is used for pump down or emptying applications).

In **PUMP ▲** mode, the relays turn **ON** as the level drops below the set points and remains **ON** until the level rises above the set point (the **PUMP ▲** mode is used for pump up or filling applications).

RUN SIG**USED/UNUSED**

USED: The pump run indication LEDs are dependent on input signals 1, 2, 3, 4 from motor starter auxiliary contacts.

UNUSED: The pump run indication LEDs are on when the output relays for pump control are energized.

RES CTRS**RESET ALL COUNTERS**

Enter 12 in this field and all counters will be reset to zero.

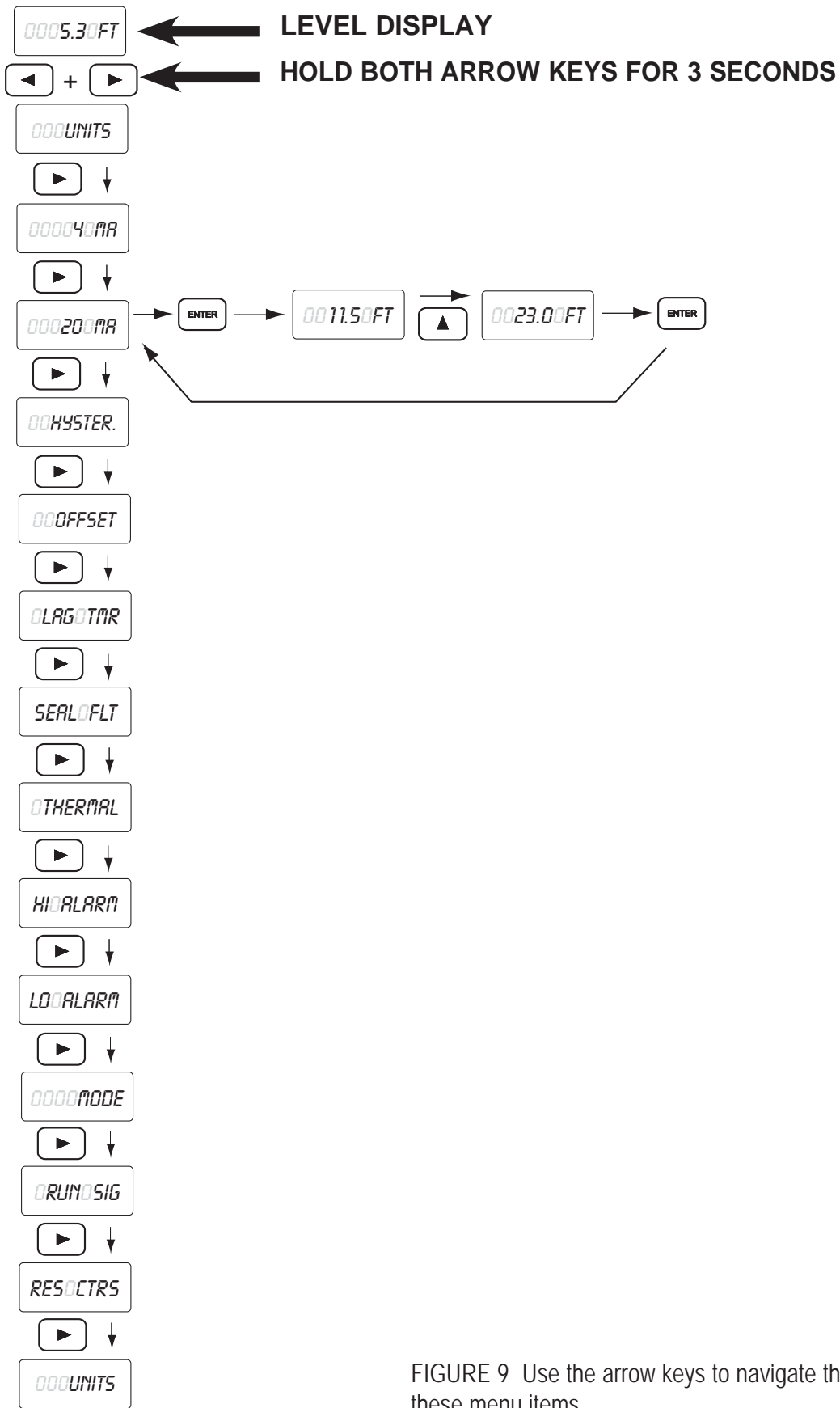

FIGURE 9 Use the arrow keys to navigate through these menu items.

NOTE: Eight (8) seconds of inactivity (no keys pressed) will terminate the configuration menu and exit back to the run menu.

RUN MODE PARAMETERS

	MIN	MAX	DEFAULT	USER FUNCTION	USER VALUE
LEVEL DISPLAY	-9.9	999.9	SENSOR on invalid input signal		
<i>LOLEVEL</i>	0.0	999.9	2.0 FT		
<i>OSTOPOLD</i>	0.0	999.9	3.0 FT		
<i>STOPLAG</i>	0.0	999.9	4.0 FT		
<i>OSTAROLD</i>	0.0	999.9	5.0 FT		
<i>STAROLAG</i>	0.0	999.9	6.0 FT		
<i>HIDLEVEL</i>	0.0	999.9	7.0 FT		
<i>ALTERNAT</i>	AUTO 1-2/2-1		AUTO		
<i>DETM10HR</i>	READ ONLY				
<i>DETM20HR</i>	READ ONLY				
<i>00000EC1</i>	READ ONLY				
<i>00000EC2</i>	READ ONLY				
<i>SIMULATE</i>	4 mA value in configuration	20 mA value in configuration			

NOTES:

SP6R LEVEL CONTROLLER

The **SP6R Level Controller** is an **easy-to-use** micro-processor-based controller which monitors any **4-20 mA** signal. It has six programmable relay outputs that can be used for control and alarm. The transducer input zero and span are full configurable. A simulation mode allows the user to test the set points and relay operation. The controller can be configured for pump up or pump down applications. **Applications** include: level monitoring, pressure, temperature, flow and analytical.

NEMA 4X

The SP6R Set Point Controller is also available in a **NEMA 4X** enclosure. These units are ideal for replacing float switch or "bubbler" control systems. Call today for more information.



**ASSEMBLED
IN THE
USA**



WWW.PRIMEXCONTROLS.COM

Ashland, OH

Clearwater, FL

Detroit Lakes, MN

Milford, OH

800-363-5842

800-349-1905

888-342-5753

513-831-9959