

# PC-3000X PC-3000XC PUMP CONTROLLER

## User Manual

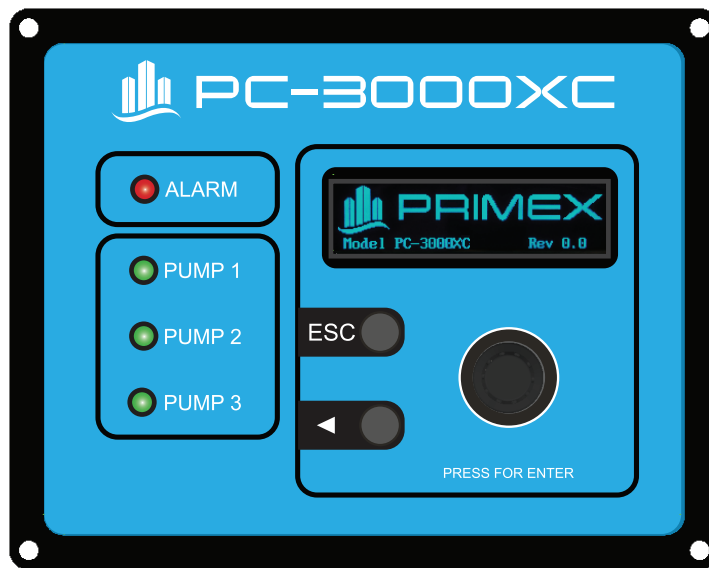

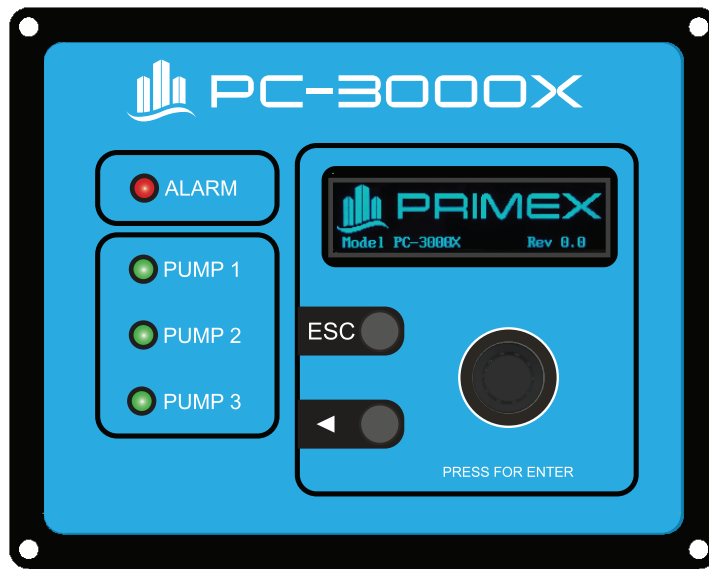



WWW.PRIMEXCONTROLS.COM  
844-4PRIMEX (844-477-4639)

# TABLE OF CONTENTS

Warnings .....	1
Introduction and Specifications .....	2
Main Screen (Programming) .....	3
User Interface .....	3
Main Menu .....	4
Alternation .....	4
Level Setpoints .....	4
Counts and ETMS .....	5
Flow Measurements .....	6
Level Simulation .....	6
Advanced Settings .....	7
I/O Status Screens .....	11
Remote Fault Status .....	12
Pump Down Operation .....	12
Pump Up Operation .....	14
Level Alarms .....	15
Pump On/Off Delay Timers .....	15
Pump Start Failure Detection and External Disable Inputs .....	15
Setpoint Dwell Time .....	16
Alarms (Definition and Fixes) .....	16
Power Up Screen .....	18
I/O Terminal Configuration .....	18
I/O Table .....	19
PC-3000X MODBUS (Basic) .....	20
PC-3000X MODBUS Register List .....	21
PC-3000XC MODBUS (Advanced) .....	22
PC-3000XC MODBUS Expanded Register List .....	26
Mounting Dimensions .....	28
Controller Dimensions .....	29
Retrofit Replacement of a PC-3000 .....	30
Electrical Wiring Diagram .....	32
Controller Setpoints List .....	33

# WARNINGS

Failure to read and understand the information provided in this manual may result in personal injury or death, damage to the product or product failure. Please read each section in its entirety and be sure you understand the information provided in the section and related sections before attempting any of the procedures or operations given.

Failure to follow these precautions could result in serious injury or death. Keep these instructions with warranty after installation. This product must be installed in accordance with National Electrical Code, ANSI/NFPA 70 so as to prevent moisture from entering or accumulating within the controller housing.	
 <b>WARNING</b>	<b>ELECTRICAL SHOCK HAZARD</b> A qualified service person must install and service this product according to applicable codes and electrical schematics. Disconnect power prior to servicing any equipment.
	<ul style="list-style-type: none"><li>• Do not connect power to this equipment if it has been damaged or has any missing parts.</li><li>• The PC-3000X or PC-3000XC contains no serviceable parts; do not attempt to repair this equipment.</li><li>• Do not install in areas with: excessive or conductive dust, corrosive or flammable gas, moisture or rain, excessive heat, regular impact shocks, or excessive vibration.</li></ul>
 <b>WARNING</b>	<b>EXPLOSION OR FIRE HAZARD</b> Do not use this product with flammable liquids. Do not install in hazardous locations as defined by National Electrical Code, ANSI/NFPA 70.
	

**Note: The float backup options talked about in this manual provide a backup for a level transmitter failure only. They are integral to the PC-3000X or PC-3000XC controller, and do not provide backup operation in the event of total controller failure. A separate backup alarm float should always be used.**

**Warning: Users must read this manual and understand controller operation before changing any settings. Entering incorrect settings may result in damage to equipment.**

**If the controller was shipped pre-installed in a control panel, some default values may have been changed at the factory in order to properly test the control panel operation. The user must adjust the settings to the requirements of their particular installation**

**The user should always keep a record of the settings before making changes, in case there is a need to revert to previous settings. The user should also record all settings changed for use in programming a new controller in case a replacement is ever needed.**

**Always thoroughly test controller operation in the installed configuration to verify user settings.**

# INTRODUCTION & SPECIFICATIONS

Congratulations and thank you for your purchase of the PC-3000X or PC-3000XC controller. This manual explains the features and operations of the controller which was designed to operate up to 3 pumps in a pump up or pump down application. The controller sequences pumps on and off in response to a change in level input. When used to control the level in a tank, the input is connected to a 4-20mA pressure transmitter or ultrasonic transmitter. The PC-3000XC contains all the features of the PC-3000X, with the addition of adjustable serial communications parameters, remote pump control, and expanded number of available Modbus registers. The controller features a rotary selector wheel in addition to back and escape pushbuttons for intuitive menu navigation and quick setting adjustments.

## GENERAL

One, two or three pump controller  
Pump up or pump down  
Configurable units  
Operates using 4-20mA level transmitter  
Scalable 4-20mA output  
Input for transmitter back up float switch  
Rotary selector for menu navigation  
2.7" blue OLED 64 x 256 pixel display

## DIMENSIONS

7.2 x 5.7 x 2.5 inches (18.3 x 14.5 x 6.4 cm)

## PUMP CONTROL AND PROTECTION

Automatic pump alternation  
Multiple alternation configurations  
Pump seal fail detection  
Pump overtemp detection  
Pump fail to start  
Pump run indication  
Constant or variable speed

## SYSTEM

Cycle counter/hour meters

- Alarm counts
- Number of starts for each pump
- Run time for each pump

Level simulation



**LISTED**

IND. CONT. EQ.  
38V6

File #E305146

## ELECTRICAL SPECIFICATIONS

### Power

- 24 VDC (19-28 VDC, 325mA max)
- Optional battery backup

### Dedicated I/Os

- 11 digital inputs
- 6 relay outputs (120 VAC, 3A Max.)
- 1 analog input (4-20mA, 14 bit resolution, non isolated)
- 1 analog output (4-20mA, 12 bit resolution, non isolated, fully scalable)

### Serial Communication Port

- RS-485 3-Wire (half duplex)
- Modbus RTU
- 9600 baud, 1 stop bit, no parity
- Compatible with the PRIMEX® Pump Watch™ Express Gateway.

### PC-3000XC Only:

- Adjustable baud rate
- Adjustable Modbus Node Address
- Remote Pump Run and Pump Inhibit

## ENVIRONMENT

Operational temperature -4°F to 158°F (-20°C to 70°C)

Storage temperature -4°F to 158°F (-20°C to 70°C)

Relative Humidity (RH) 5% to 95% (non-condensing)

Indoor rated—for indoor use or mounted inside of an outdoor rated enclosure

# PROGRAMMING

## MAIN SCREEN

The main screen gives the operator an overview of the lift station status including any active alarms.

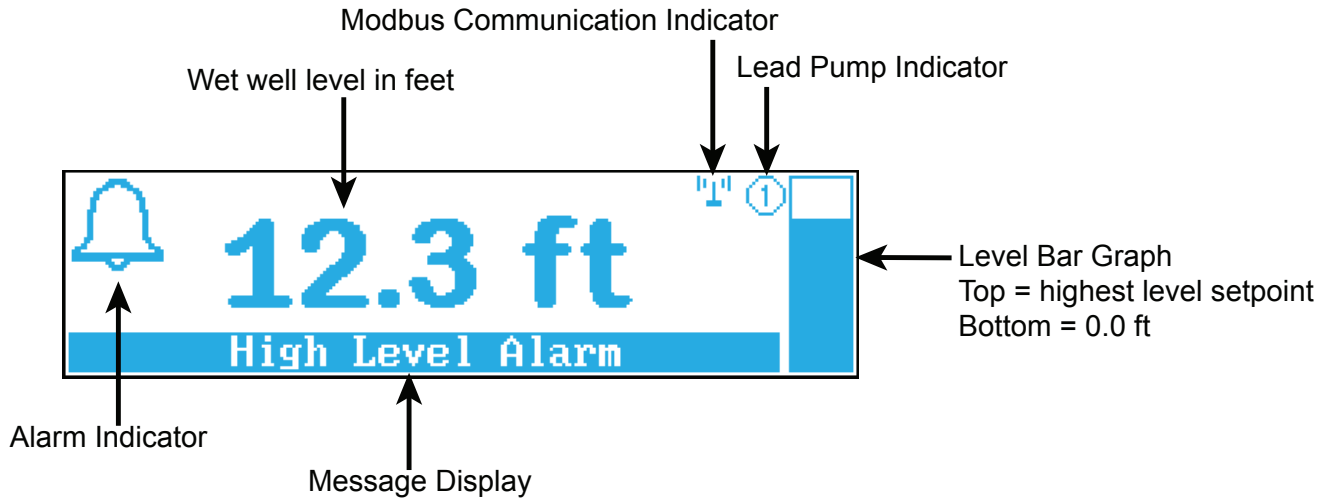

## USER INTERFACE

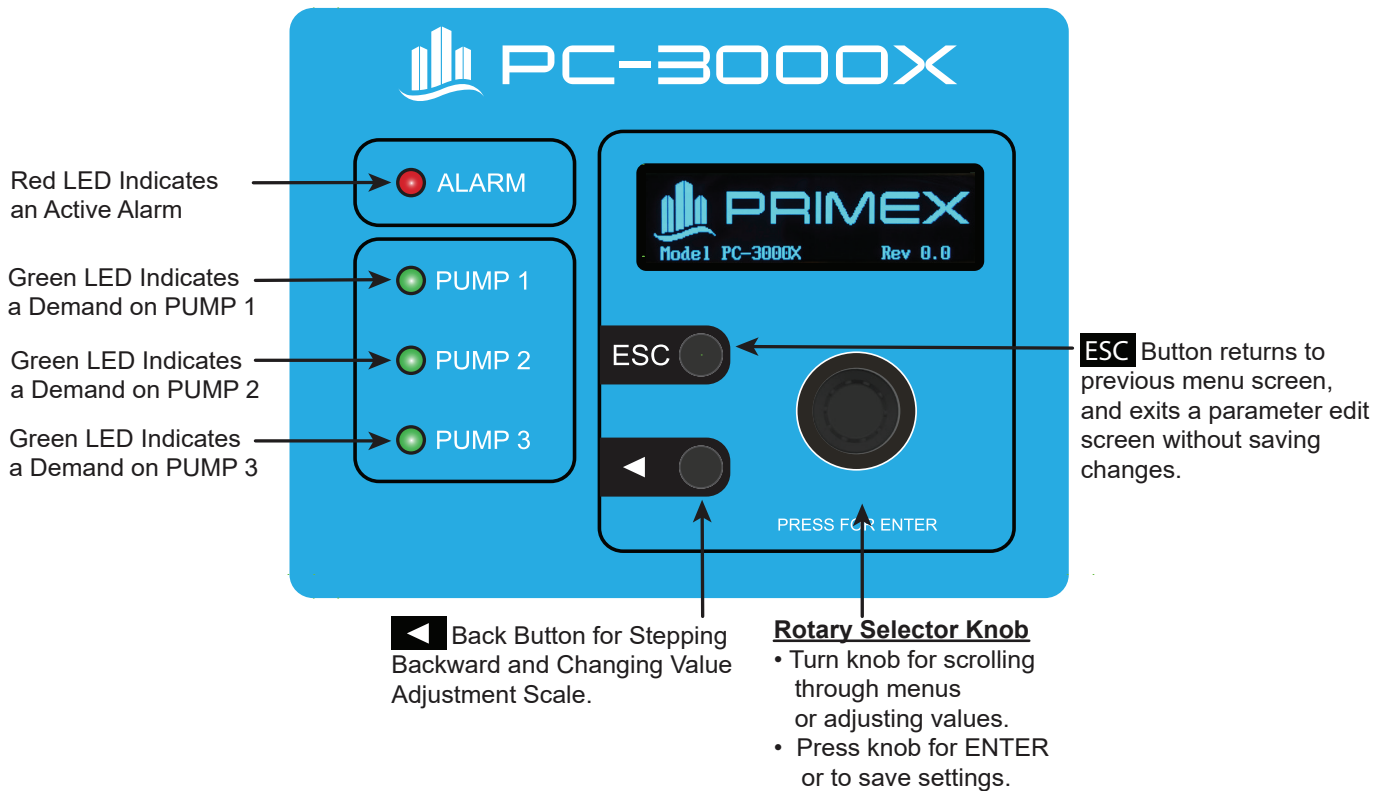

## MAIN MENU

While in the Main Display screen, press the ENTER button to view the Main Menu.

— Main Menu —	
Alternation	
Level Setpoints	
Counts and ETMs	
Flow Measurements	
Level Simulation	Disabled
Advanced Settings	

## ALTERNATION

— Edit Alternation —	
Alternate	
Pump 1 Lead	
Pump 2 Lead	
Pump 3 Lead	

## LEVEL SETPOINTS

These are the Level Setpoints that can be adjusted.

↓ — Level Setpoints —	
Lead Pump ON	10.0 ft
Lead Pump OFF	6.0 ft
Lag Pump ON	11.0 ft
Lag Pump OFF	6.0 ft

↑ — Level Setpoints —	
Lag2 Pump ON	12.0 ft
Lag2 Pump OFF	6.0 ft
High Level Alarm	16.0 ft
Low Level Alarm	4.0 ft

An edit screen can be brought up by pressing the selector wheel when the desired setpoint is highlighted.

— Edit Lead Pump ON —	
010.0 ft	
Min: 0.1	Max: 20.0

To adjust the value, scroll the wheel to the desired value and click the ENTER wheel to save the setting. The adjustment scale will default to tenths. The adjustment scale can be set to tenths, ones, tens and hundreds. Tenths is shown in example. Depending on the specific adjustment, hundreds may not be an option.

To adjust the scale, click the ◀ button until the desired increment is highlighted.



Ones will be adjusted



Tens will be adjusted



Hundreds will be adjusted

The default scale is feet. This can be changed using the advanced settings menu.

To ignore any changes and return to the previous screen, press the ESC button or press and hold the ◀ button.

### COUNTS AND ETMS (ELAPSED TIME METERS)

The following three screens show the nine different Counts and ETMs that are tracked.

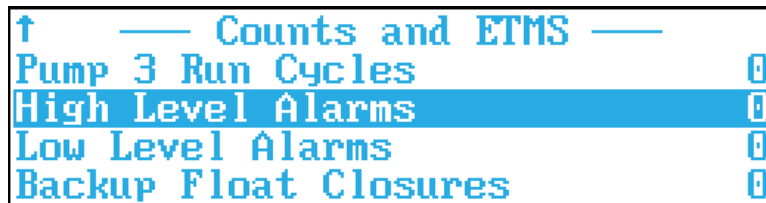
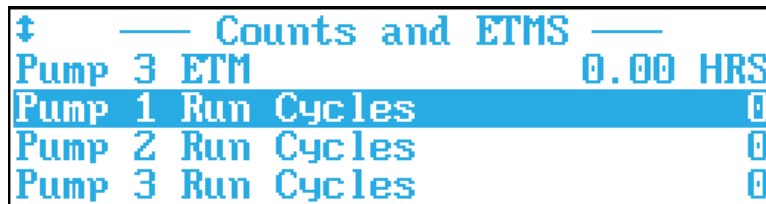

A CLEARING COUNT APPROVAL screen can be brought up by clicking the ENTER button when the desired count is highlighted. Pump ETMs cannot be cleared.

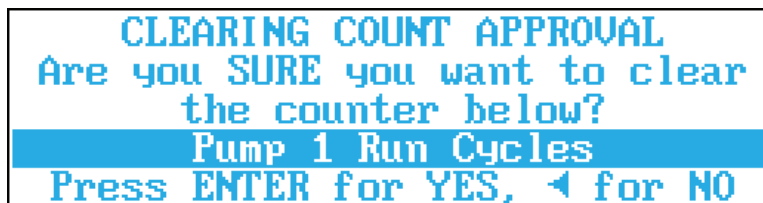

Following the onscreen directions, press ENTER for YES, ◀ for NO.

If ENTER is pressed, the next screen will ask if you are sure you want to clear. If ENTER is pressed for YES here, the count is permanently cleared to zero, and this action cannot be reversed.

**WARNING!**  
Clearing the count is permanent  
and cannot be reversed.  
Are you SURE you want to clear?  
Press ENTER for YES, ◀ for NO

If ◀ for NO is pressed, you will be returned to the main Counts and ETMs screen.

## FLOW MEASUREMENTS

This screen shows the four flow rates that are calculated by the controller. The calculations are based on the Tank Diameter (see STATION DATA menu), and the tank fill time from Lead Pump Off level to Lead Pump On level (for Station Inflow) or tank discharge time from Lead Pump On level to Lead Pump Off level (for Pump GPM). The value shown is always for the most recently completed fill or discharge cycle.

— Flow Measurements —	
Station Inflow	999 GPM
Pump 1 Flow	999 GPM
Pump 2 Flow	999 GPM
Pump 3 Flow	999 GPM

## LEVEL SIMULATION

When **Level Simulation** is Enabled, use the selector wheel to simulate input level changes. This can be helpful for troubleshooting a system to make sure the controller is functioning correctly without actually having various level scenarios available. After two minutes without use this will automatically default to input level transmitter.

— Edit Level Simulation —  
Disabled  
Enabled

**38.4 in** 1  
Simulate Mode (ESC to exit)  
Hold down ◀ for coarse adj.

Rotate the selector wheel to make fine adjustments. To make coarse adjustments, press and hold the ◀ button while rotating the selector wheel.



# ADVANCED SETTINGS

The Advanced Settings menu contains the following 18 settings.

— Advanced Settings —	
Transmitter Range	15.0 ft
Level Offset	0.0 ft
Number of Pumps	3
Pump ON Delay	5 sec
Pump OFF Delay	5 sec
Setpoint Dwell Time	2 sec
Backup Float Run Time	0 sec
Aux/Dis Input Function	Feedback
Starter Run Feedback Time	2 sec
Seal Fail Polarity	Normal
Temp Fail Reset Mode	Auto-Reset
Aux Relay Function	Horn
Mute/Rst/PwrFail Funct.	Mute/Rst
Max Pumps On At Once	3
Analog Out Low Level	0.0 ft
Analog Out High Level	15.0 ft
Level Units	Feet
Pumping Direction	Down
☐ I/O Status	
☐ Remote Fault Status	
☐ Station Data	
☐ Modbus Parameters	← PC-3000XC Only

## TRANSMITTER RANGE

Enter the full range of your level transmitter. For example, for a 0-20' WC transmitter, the Transmitter Range setting should be "020.0 ft". Allowable range: 1.0 to 999.9.

## LEVEL OFFSET

Use the Level Offset if you want the displayed level to take into account space between the bottom of the level transmitter and the bottom of the tank. If the level transmitter was mounted one foot above the bottom of the tank, the Level Offset setting should be "001.0 ft". All level setpoints are referenced to the displayed level, which includes any Level Offset. Allowable range: 0.0 to (999.9 – Transmitter Range).

## NUMBER OF PUMPS

Enter the number of pumps you are using. When set to '2', the controller operates as a duplex controller using pumps 1 and 2. When set to '1', the controller operates as a simplex controller using pump 1 only. Allowable Range: 1 to 3.

## PUMP ON DELAY

This setting controls the minimum time allowed between one pump turn on and the next pump turn on. If set to zero, this will allow multiple pumps to turn on simultaneously. Note: the Pump ON Delay does not affect the first pump to turn on after power up. Allowable range: 0 to 250 seconds.

## PUMP OFF DELAY

This setting controls the minimum time allowed between one pump turn off and the next pump turn off. If set to zero, this will allow multiple pumps to turn off simultaneously. Note: the Pump OFF Delay does not affect the first pump to turn off after power up. Allowable range: 0 to 250 seconds.

## SETPOINT DWELL TIME

The controller provides a means of dealing with varying input levels around setpoints. The Setpoint Dwell Time is a minimum time a setpoint level must stay active before the setpoint is recognized. The interval can be set to a value from 0 to 99 seconds. A value of zero means the setpoint level will be instantly recognized. This feature can be useful in water pressure systems where the pressure may rapidly vary for several seconds after a pump is turned off or on. In this example, the SETPOINT DWELL TIME setting should be set longer than the pressure takes to settle so pumping will wait until the new pressure has stabilized. Allowable range: 0 to 99 seconds.

***Example:** assume the SETPOINT DWELL TIME setting is set to 8 seconds, and the LEAD setpoint is set to 10 inches. In a pump down system, if the level goes up and stays  $\geq 10$  inches, the controller will recognize the setpoint as active after 8 seconds have passed. If within 8 seconds the level drops below 10 inches, the level is not recognized and the dwell timer is reset.*

## BACKUP FLOAT RUN TIME

Set this value to the amount of time the pump(s) should continue to run after the backup float tips back down. Setting this to 0 seconds will disable the float backup pump run feature, while still allowing the float backup high level alarm feature to work. Allowable range: 0 to 999 seconds.

## AUX/DIS INPUT FUNCTION

The Aux/Dis inputs can be set to function one of two ways:

**Starter Run Feedback** – The Aux/Dis input for each pump is feedback from the motor contactor or other device (flow switch, current sensor, etc.) confirming that the pump started when it was called. From the time a pump is called to run, the Aux/Dis input for the corresponding pump must close (short to COM) within the amount of time defined in Starter Run Feedback Time, or else the Pump Fail To Start fault will be activated.

**Pump Disable** – The Aux/Dis input for each pump is a “pump disable” input, preventing the corresponding pump from being called to run any time the input is closed (shorted to COM).

## STARTER RUN FEEDBACK TIME

When the Aux/Dis Input Function setting is set to “Starter Run Feedback”, this setting controls how long the controller will wait after a pump is called to run for the corresponding Aux/Dis input to close. If the Aux/Dis Input Function setting is set to “Pump Disable”, this setting has no effect. Allowable Range: 1 to 99 seconds.

## SEAL FAIL POLARITY

By default, the Seal Fail Polarity is set to Normal, which means the seal fail fault trips when the resistance in the seal probe drops below 50k $\Omega$ . When Seal Fail Polarity is set to Inverted, the seal fail fault trips when the resistance in the seal probe increased above 75k $\Omega$ .

**Note:** if using a single-wire seal probe, the probe should be wired to the seal leak input terminal; no connection of the seal probe to the COM terminal is necessary if the controller is properly grounded.

## TEMP FAIL RESET MODE

By default the Temp Fail Reset Mode is set to Auto-Reset. After a pump overtemp sensor trips, the contacts will re-close after a cooldown. In Auto-Reset mode, a pump will be available to be called when this happens. When Temp Fail Reset Mode is set to Latched, the pump will not be returned to service until manually reset by an operator by pressing the ESC pushbutton or externally using the MUTE/RESET input.

## AUX RELAY FUNCTION

The Aux/Horn relay output can operate in one of several different modes:

**Horn** – This setting is intended to be used with an audible alarm. The relay will close on a high level alarm, low level alarm, or high level float fault. If an operator uses an external pushbutton on the MUTE/RESET input (or if the alarm condition goes away), this relay will open.

**Seal** – The relay will close if there is a seal fail condition on any pump.

**Temp** – The relay will close if there is a temperature fail condition on any pump.

**Temp-Seal** – The relay will close if there is a seal fail or temperature fail condition on any pump.

**All** – The relay will close if there is a high level alarm, low level alarm, high level float alarm, or seal fail or temperature fail condition on any pump.

## MUTE/RESET/POWERFAIL FUNCTION

To use the Mute/Reset digital input (terminal J3-9) as an input for a Mute (also known as Silence) pushbutton, set Mute/Reset/PowerFail Function to “Mute/Reset Pushbutton”. To instead use that digital input as an indication of a main power failure (when using a 24VDC backup battery to power the controller), use the “Power Fail Detection” setting. A power failure condition is detected whenever that input is closed. When a power fail occurs, an alarm message will be shown on the main screen immediately. If you are using Modbus communication for a telemetry device such as the PRIMEX PumpWatch, the power fail fault indication Modbus bit will be delayed by the number of seconds indicated in the Power Fail Delay Time setting. This allows the system to recover from very brief power outages without remote alarm notification.

## MAX PUMPS ON AT ONCE

Typically, the Max Pumps On At Once will be set the same as Number Of Pumps. However, if for reasons of limiting the maximum current or maximum flow, the number of pumps running at the same time needs to be limited, this setting can be lowered.

## ANALOG OUT LOW LEVEL

This setting defines the displayed level reading that corresponds with 4.0mA on the analog output. This can be set below or above the Analog Out High Level setting.

## ANALOG OUT HIGH LEVEL

This setting defines the displayed level reading that corresponds with 20.0mA on the analog output. This can be set above or below the Analog Out Low Level setting.

*Example: If you want the 4-20mA output to be scaled such that it outputs 4mA at a 5.0-ft level reading, and 20mA at a 10.0-ft level reading, you would set the Analog Out Low Level setting to 5.0 ft, and the Analog Out High Level setting to 10.0 ft.*

## LEVEL UNITS

This setting defines what units label is applied to the level input reading and all level settings. The available settings are: inches, feet, meters, centimeters, PSI, kPa, and bar.

## PUMPING DIRECTION

While most applications of the controller are for a pump down system, it can also be used in pump up applications. Because this represents a major shift in how the controller operates, when changing from one pumping direction to the other, all other user settings are set to default values. To prevent this from occurring accidentally, changing the pumping direction requires progressing through two confirmation screens.

Note: If for some reason the user wishes to restore all settings to factory defaults, this can be done by changing the Pumping Direction, then changing it back again.

## STATION DATA

This information is not used in any control or alarm functions, and is simply for the user's future reference. The pump's horsepower, voltage, and FLA, as well as the tank diameter and height of the tank inlet, can be entered here and referred to at a later date.

— Station Data —	
Pump Horsepower	999
Pump Voltage	999
Pump FLA	999.9 FLA
Tank Diameter	999.9 ft
Inlet Height	999.9 ft

## I/O STATUS SCREENS

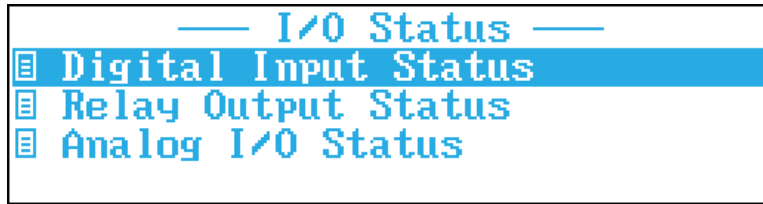

### DIGITAL INPUT STATUS

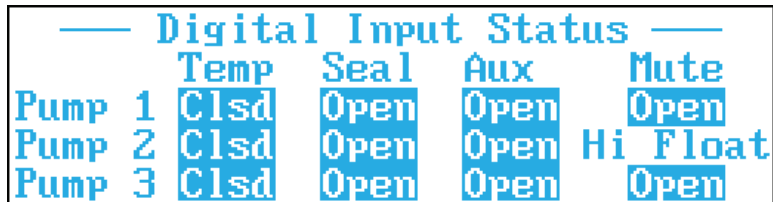

This screen shows the status of all eleven digital (discrete) inputs. Each input is shown as either open circuit (“Open”) or closed circuit, meaning shorted to COM (“Clsd”). This can be used for troubleshooting to make sure the controller is seeing changes in input states.

### RELAY OUTPUT STATUS

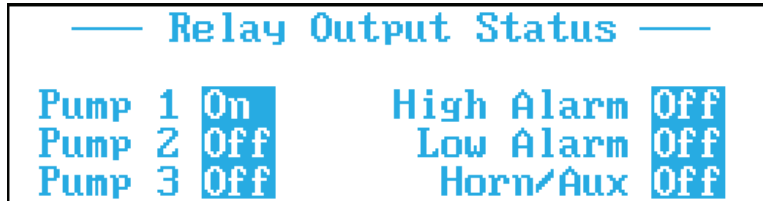

This screen shows the status of all six relay outputs. Each relay output is shown as either open circuit (“Off”) or closed circuit (“On”). This can be used for troubleshooting to make sure the controller is turning on and off the output relays you expect it to.

### ANALOG I/O STATUS



This screen shows the current in mA of the analog input (AI LEVEL) and analog output (A OUT). This can be used for troubleshooting to make sure the 4-20mA signals are behaving as expected.

# REMOTE FAULT STATUS

The Remote Fault Status menu contains the following two settings.

— Remote Fault Status —	
Power Fail Delay Time	20 sec
Max. Pump Run Time	0.0 hr

## POWER FAIL DELAY TIME

This setting controls the number of seconds of delay after a power failure is detected (on input J3-9) until the Power Fail fault is indicated via Modbus. Allowable range: 0 to 999 seconds.

## MAX. PUMP RUN TIME

If any pump runs continuously for the amount of time specified by this setting, the Max Run Time fault is indicated via Modbus. Note: this fault will not turn off the pump or otherwise affect the running of the pump(s); it is for Modbus notification only. Turn off this feature by setting Max. Pump Run Time to 0. Allowable range: 0 to 99.9 hours.

# OPERATION

## PUMP DOWN OPERATION

Pump down control is used in applications (example: wastewater lift stations), where a liquid flows into a tank and must be pumped out. A level transmitter sends the present level to the controller where it is continually monitored and displayed.

### Pump Down Operation with Number of Pumps = 1

When Number of Pumps = 1, the only pump controlled will be Pump 1, and the Lead Pump ON/OFF setpoints are used. When the level rises above the Lead Pump ON Setpoint, the pump will be called to run; when the level drops below the Lead Pump OFF Setpoint, the pump will be turned off.

### Pump Down Operation with Number of Pumps = 2

When Number of Pumps = 2, the Lead pump will initially be Pump 1 and the Lag pump will be Pump 2.

### Pump Operation when Sequence = Pump 1 Lead or Pump 2 Lead

When the level rises above the Lead Pump ON Setpoint, the Lead pump will be called to run; when the level drops below the Lead Pump OFF Setpoint, the Lead pump will be turned off. If the level rises to the Lag Pump ON setpoint, the Lag pump will run; when the level drops below the Lag Pump OFF Setpoint, the Lag pump will be turned off.

### Pump Operation when Sequence = Alternate

Pumping works the same as mentioned in the previous paragraph, except when any pumps were running and all have turned off, the pump assignment will alternate as follows:

Current Pump Assignment		Next Pump Assignment	
Lead	Lag	Lead	Lag
Pump 1	Pump 2	Pump 2	Pump 1
Pump 2	Pump 1	Pump 1	Pump 2

### Pump Down with Number of Pumps = 3

When Number of Pumps = 3, the Lead pump will initially be Pump 1, the Lag pump will initially be Pump 2, and the Lag2 pump will initially be Pump 3.

### Pump Operation When Sequence = Pump X Lead

When the level rises above the Lead Pump ON Setpoint, the Lead pump will be called to run; when the level drops below the Lead Pump OFF Setpoint, the Lead pump will be turned off. If the level rises to the Lag Pump ON setpoint, the Lag pump will run; when the level drops below the Lag Pump OFF Setpoint, the Lag pump will be turned off. If the level rises to the Lag2 Pump ON setpoint, the Lag2 pump will run; when the level drops below the Lag2 Pump OFF Setpoint, the Lag2 pump will be turned off.

### Pump Operation When Sequence = Alternate

Pumping works the same as mentioned in Pump X Lead above, except when any pumps were running and all have turned off, the pump assignment will alternate as follows:

Current Pump Assignment			Next Pump Assignment		
Lead	Lag	Lag2	Lead	Lag	Lag2
Pump 1	Pump 2	Pump 3	Pump 2	Pump 3	Pump 1
Pump 2	Pump 3	Pump 1	Pump 3	Pump 1	Pump 2
Pump 3	Pump 1	Pump 2	Pump 1	Pump 2	Pump 3

### Pump Down Single Float Backup System

In pump down applications, a single float backup system is available to provide a redundant means of pumping. If the level transmitter fails, the backup system can provide pump control to prevent potential problems. A normally open float switch is positioned in the tank to close at levels above normal pumping levels, and is connected to the HIGH FLOAT input. If the level rises above the backup float switch position, the Backup System will activate. The Backup System is enabled when the BACKUP FLOAT RUN TIME setting is a non-zero value.

If the Backup System float closes, and backup is enabled, and the controller is not already calling for all available pumps then the backup mode is initiated and the lead pump is called to run. If the level drops below the Backup System float position, the lead pump will continue to pump for the BACKUP FLOAT RUN TIME interval. If the level does not drop below the Backup System float position within 30 seconds of the lead pump turning on, and the system has more than one pump available, the lag pump will then also turn on; if the level does not drop within 60 seconds of the lead pump turning on, and the system has more than two pumps available, the Lag2 pump will then also turn on. If either

of the lag pumps runs and the level drops below the Backup System float position, each of the lag pumps will respectively pump for the BACKUP FLOAT RUN TIME interval from when the float switch opened before turning off. Activation of the Backup System will be indicated on the display and remain until cleared by the ESC button or the external reset/mute button.

This single float backup provides a backup for a level transmitter failure only. It is integral to the controller, and does not provide backup operation in the event of total controller failure. A separate backup alarm float should always be used.

## PUMP UP OPERATION

Pump up control is used in applications (example: water distribution or water tower), where pressure must be controlled in a fill tank. In such an application, the level is sensed by a pressure transmitter mounted in the base of the tank. The controller operates pumps to raise the level (and therefore pressure) in the tank. Simply viewed, pump up control is like pump down control but the setpoints are inverted.

### Pump Up Operation with Number of Pumps = 1

When Number of Pumps = 1, the only pump controlled will be Pump 1, and the Lead Pump ON/OFF setpoints are used. When the level drops below the Lead Pump ON Setpoint, the pump will be called to run; when the level rises above the Lead Pump OFF Setpoint, the pump will be turned off.

### Pump Up Operation with Number of Pumps = 2

When Number of Pumps = 2, the Lead pump will initially be Pump 1 and the Lag pump will be Pump 2.

#### Pump Operation when Sequence = Pump X Lead

When the level drops below the Lead Pump ON Setpoint, the Lead pump will be called to run; when the level rises above the Lead Pump OFF Setpoint, the Lead pump will be turned off. If the level drops to the Lag Pump ON setpoint, the Lag pump will run; when the level rises above the Lag Pump OFF Setpoint, the Lag pump will be turned off.

#### Pump Operation when Sequence = Alternate

Pumping works the same as mentioned in Pump X Lead above, except when any pumps were running and all have turned off, the pump assignment will alternate as follows:

Current Pump Assignment		Next Pump Assignment	
Lead	Lag	Lead	Lag
Pump 1	Pump 2	Pump 2	Pump 1
Pump 2	Pump 1	Pump 1	Pump 2

### Pump Up with Number of Pumps = 3

When Number of Pumps = 3, the Lead pump will initially be Pump 1, the Lag pump will initially be Pump 2, and the Lag2 pump will initially be Pump 3.

#### Pump Operation When Sequence = Pump X Lead

When the level drops below the Lead Pump ON Setpoint, the Lead pump will be called to run; when the level rises above the Lead Pump OFF Setpoint, the Lead pump will be turned off. If



the level drops to the Lag Pump ON setpoint, the Lag pump will run; when the level rises above the Lag Pump OFF Setpoint, the Lag pump will be turned off. If the level drops to the Lag2 Pump ON setpoint, the Lag2 pump will run; when the level rises above the Lag2 Pump OFF Setpoint, the Lag2 pump will be turned off.

### **Pump Operation When Sequence = Alternate**

Pumping works the same as aforementioned Pump X Lead, except when any pumps were running and all have turned off, the pump assignment will alternate as follows:

Current Pump Assignment			Next Pump Assignment		
Lead	Lag	Lag2	Lead	Lag	Lag2
Pump 1	Pump 2	Pump 3	Pump 2	Pump 3	Pump 1
Pump 2	Pump 3	Pump 1	Pump 3	Pump 1	Pump 2
Pump 3	Pump 1	Pump 2	Pump 1	Pump 2	Pump 3

### **Level Alarms**

When the level is equal to or below the Low Level Alarm Setpoint, a low alarm condition will be activated and will remain active until cleared. When a low alarm is active, the low alarm relay contacts will be closed, and the horn relay contacts will be closed (if AUX RELAY FUNCTION = HORN or ALL). A low alarm condition is cleared when the level rises above the Low Level Alarm Setpoint.

When the level is equal to or above the High Level Alarm Setpoint, a high alarm condition will be activated and will remain active until cleared. When a high alarm is active, the high alarm relay contacts will be closed, and the horn relay contacts will be closed (if AUX RELAY FUNCTION = HORN or ALL). A high alarm condition is cleared when the level is below the High Level Alarm Setpoint.

### **Pump On/Off Delay Timers**

The controller provides a means of preventing one or more pumps from starting or stopping at the same time. The PUMP ON DELAY setting is an interval to wait after a pump turns on before allowing another pump to turn on. The PUMP OFF DELAY setting is an interval to wait after a pump turns off before allowing another to turn off. The PUMP ON DELAY and the PUMP OFF DELAY settings can be set to a value from 0 to 250 seconds. A PUMP ON DELAY setting of zero will allow pumps to turn on simultaneously; a PUMP OFF DELAY setting of zero will allow pumps to turn off simultaneously.

### **Pump Start Failure Detection and External Disable Inputs**

The controller provides inputs to detect pump failure-to-start conditions and the same inputs can be used to externally disable pumps.

#### **Pump Start Failure Detection Inputs**

To use the inputs as start failure detection inputs, the AUX/DIS INPUT FUNCTION setting must be set to STARTER FEEDBACK. The controller monitors the Aux/Disable input to detect a pump failure to start condition. A fault is detected if a contact closure from the input to ground is not made within the startup detect interval. The STARTUP DETECT INTERVAL setting can be set from 1 to 99 seconds. For example, say STARTUP DETECT INTERVAL is set to 15 seconds and a pump is called to start. If the Aux/Disable input for that pump is not connected to ground within 15 seconds, a pump failure to start will be reported.

The failure will be reported on the display until reset by an operator by pressing the ESC push-button or externally using the MUTE/RESET input. When a pump failure occurs, a message will be reported, the horn relay contacts will be closed (if Horn = ENABLED) and the pump will be removed from service.

### External Disable Inputs

To use the inputs as pump disable inputs, the AUX/DIS INPUT FUNCTION setting must be set to PUMP DISABLE. The controller monitors the Aux/Disable input to detect a contact closure to ground. A pump will be disabled if the Aux/Disable input shows a connection to ground.

### Setpoint Dwell Time

The controller provides a means of dealing with varying input levels around setpoints. The Setpoint Dwell Time is a minimum time a setpoint level must stay active before the setpoint is recognized. The interval can be set to a value from 0 to 99 seconds. A value of zero means the setpoint level will be instantly recognized. This feature can be very useful in water pressure systems where the pressure may rapidly vary for several seconds after a pump is turned off or on. In such a case, the SETPOINT DWELL TIME setting should be set longer than the pressure takes to settle so pumping will wait until the new pressure has stabilized

As an example, assume the SETPOINT DWELL TIME setting is set to 8 seconds, and the LEAD setpoint is set to 10 inches. In a pump down system, if the level goes up and stays  $\geq 10$  inches, the controller will recognize the setpoint as active after 8 seconds have passed. If within 8 seconds the level drops below 10 inches, the level is not recognized and the dwell timer is reset.

### Pump Runtime Limiter

When the Alternation mode is set to "Alternate", if a pump runs for 24 hours continuously, the alternator will advance to the next lead pump, turning off the currently running lead pump and starting the next pump as the new lead pump. This 24 hour period cannot be adjusted by the user.

## ALARMS

ALARM TEXT	DEFINITION	FIX
<b>HIGH LEVEL ALARM</b>	The level is at or above the High Level setpoint	Check pump operation, check in-flow, check level transducer
<b>HIGH LEVEL FLOAT</b>	The high level (backup) float is closed	Check pump operation, check in-flow, check level transducer
<b>HIGH LEVEL FLOAT (LATCHED)</b>	The high level (backup) float had closed in the past, but is now open	Press ESC to reset, check pump operation, check in-flow, check level transducer
<b>LOW LEVEL ALARM</b>	The level is at or below the Low Level setpoint	Check wet well, check level transducer
<b>PUMP 1 DISABLED</b>	The Pump 1 Disable input is closed	Open the Pump 1 Disable input
<b>PUMP 1 FAILED TO START</b>	Pump 1 was called to run but the Pump 1 Aux input did not close within the user-specified time	Press ESC to reset, check pump operation, check overload trip

# ALARMS

ALARM TEXT	DEFINITION	FIX
<b>PUMP 1 SEAL FAIL</b>	The Pump 1 seal probe input resistance to ground has dropped below 50kΩ (or above 75kΩ if Seal Fail Polarity is set to INVERTED)	Check pump seal
<b>PUMP 1 TEMP FAIL</b>	The Pump 1 temp input is open	Check voltage, pump clogging, or wear
<b>PUMP 1 TEMP FAIL (LATCHED)</b>	The Pump 1 temp input had opened in the past, but is now closed again	Press ESC to reset, check voltage, pump clogging, or wear
<b>PUMP 2 DISABLED</b>	The Pump 2 Disable input is closed	Open the Pump 2 Disable input
<b>PUMP 2 FAILED TO START</b>	Pump 2 was called to run but the Pump 2 Aux input did not close within the user-specified time	Press ESC to reset, check pump operation, check overload trip
<b>PUMP 2 SEAL FAIL</b>	The Pump 2 seal probe input resistance to ground has dropped below 50kΩ (or above 75kΩ if Seal Fail Polarity is set to INVERTED)	Check pump seal
<b>PUMP 2 TEMP FAIL</b>	The Pump 2 temp input is open	Check voltage, pump clogging, or wear
<b>PUMP 2 TEMP FAIL (LATCHED)</b>	The Pump 2 temp input had opened in the past, but is now closed again	Press ESC to reset, check voltage, pump clogging, or wear
<b>PUMP 3 DISABLED</b>	The Pump 3 Disable input is closed	Open the Pump 3 Disable input
<b>PUMP 3 FAILED TO START</b>	Pump 3 was called to run but the Pump 3 Aux input did not close within the user-specified time	Press ESC to reset, check pump operation, check overload trip
<b>PUMP 3 SEAL FAIL</b>	The Pump 3 seal probe input resistance to ground has dropped below 50kΩ (or above 75kΩ if Seal Fail Polarity is set to INVERTED)	Check pump seal
<b>PUMP 3 TEMP FAIL</b>	The Pump 3 temp input is open	Check voltage, pump clogging, or wear
<b>PUMP 3 TEMP FAIL (LATCHED)</b>	The Pump 3 temp input had opened in the past, but is now closed again	Press ESC to reset, check voltage, pump clogging, or wear
<b>TRANSDUCER SHORT CIRCUIT</b>	The 4-20mA level input signal is greater than 20.25mA	Check level transducer operation, wiring, and vent tube.
<b>TRANSDUCER OPEN CIRCUIT</b>	The 4-20mA level input signal is less than 3.75mA	Check level transducer operation, wiring, and vent tube.
<b>POWER FAILURE DETECTED</b>	The Mute/Reset/PowerFail Function setting is set to "Power Fail", and the Power Failure input (J3-9) is closed.	Verify proper control panel incoming voltage, and check for tripped breakers or blown fuses.

## POWER UP SCREEN (VERSION)

On power up, the screen will display the version of the program. Always have the version number ready when contacting the factory for service.



## I/O TERMINAL CONFIGURATION

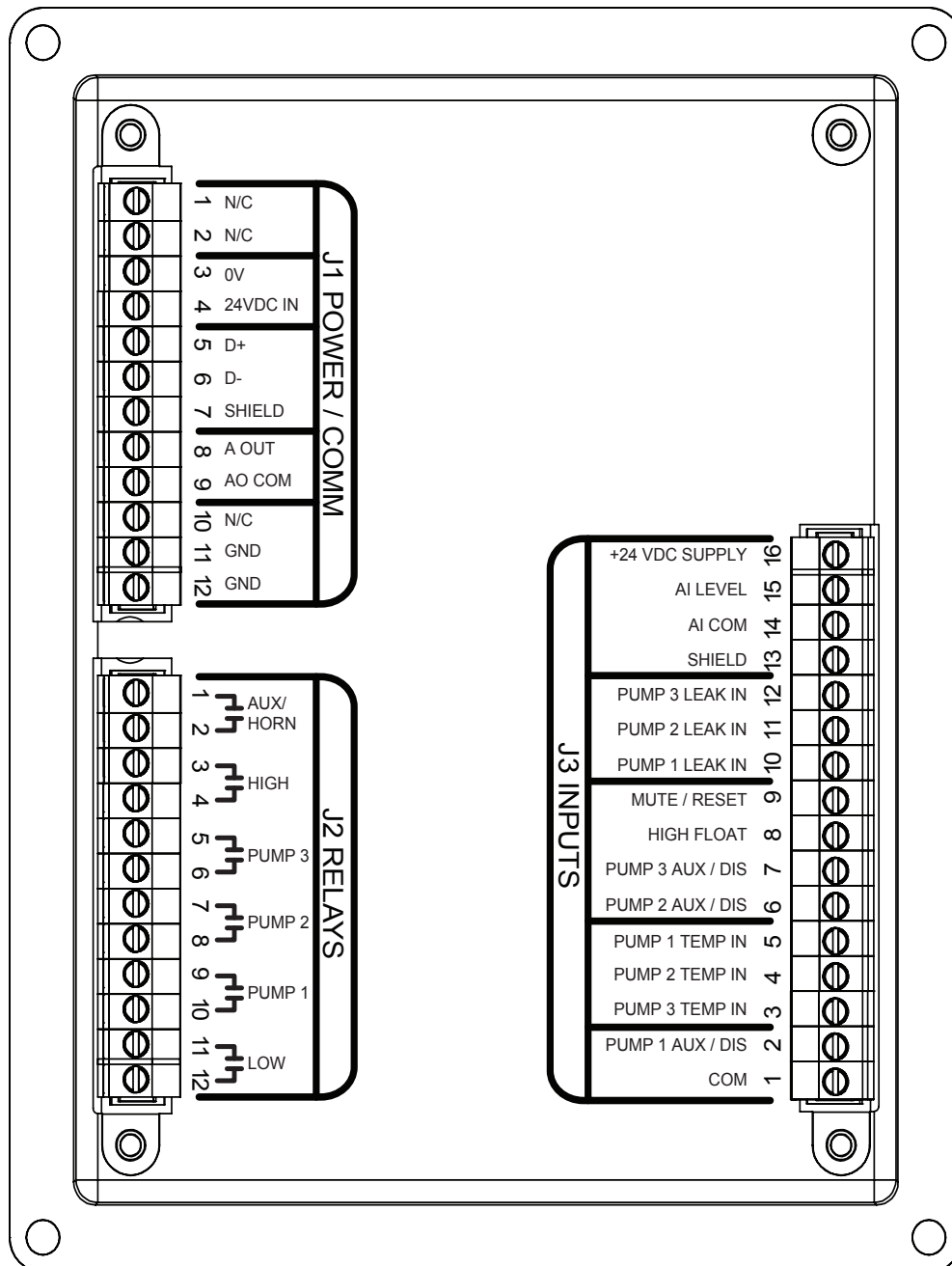

# I/O TABLE

J1 POWER AND COMMUNICATIONS		
PIN	NAME	DESCRIPTION
1	N/C	- NO CONNECTION -
2	N/C	- NO CONNECTION -
3	0V	RETURN FOR +24 VDC SUPPLY
4	+24 VDC	19 - 28 VDC SUPPLY
5	D+	MODBUS (RS-485 NON-INVERTING)
6	D-	MODBUS (RS-485 INVERTING)
7	SHIELD	
8	A OUT	4-20mA LOOP, POWER SUPPLIED
9	AO COM	4-20mA LOOP RETURN
10	N/C	- NO CONNECTION -
11	GND	PROTECTIVE EARTH GROUND
12	GND	PROTECTIVE EARTH GROUND

J2 RELAY OUTPUTS		
PIN	NAME	DESCRIPTION
1	AUX / HORN	AUX/HORN RELAY CONTACTS
2		
3	HIGH	HIGH ALARM RELAY CONTACTS
4		
5	PUMP 3	PUMP 3 RELAY CONTACTS
6		
7	PUMP 2	PUMP 2 RELAY CONTACTS
8		
9	PUMP 1	PUMP 1 RELAY CONTACTS
10		
11	LOW	LOW ALARM RELAY CONTACTS
12		

J3 DIGITAL INPUTS		
PIN	NAME	DESCRIPTION
1	COM	INPUT COMMON RETURN
2	PUMP 1 AUX / DIS	PUMP 1 AUX/DISABLE INPUT
3	PUMP 3 TEMP IN	PUMP 3 TEMP SENSOR INPUT
4	PUMP 2 TEMP IN	PUMP 2 TEMP SENSOR INPUT
5	PUMP 1 TEMP IN	PUMP 1 TEMP SENSOR INPUT
6	PUMP 2 AUX / DIS	PUMP 2 AUX/DISABLE INPUT
7	PUMP 3 AUX / DIS	PUMP 3 AUX/DISABLE INPUT
8	HIGH FLOAT	HIGH ALARM FLOAT INPUT
9	MUTE / RESET	MUTE/RESET INPUT
10	PUMP 1 LEAK IN	PUMP 1 LEAK SENSOR INPUT
11	PUMP 2 LEAK IN	PUMP 2 LEAK SENSOR INPUT
12	PUMP 3 LEAK IN	PUMP 3 LEAK SENSOR INPUT
13	SHIELD	
14	AI COM	4 - 20mA LOOP RETURN
15	AI LEVEL	4 - 20mA LOOP INPUT
16	+24 VDC OUT	LEVEL TRANSMITTER SUPPLY

**Note:**

Pins J1-3, J1-7, J1-11, J1-12, J3-1, J3-13 and J3-14 are all internally connected, and should be wired to Protective Earth Ground at terminal J1-11 or J1-12.

Use copper conductors, rated 60°C (140°F).

Apply Torque Value of 4.5 In-lbs to Field Wiring Terminals.

# PC-3000X MODBUS (BASIC)

The PC-3000X is equipped with Modbus RTU support using the D+ and D- RS-485 terminals. The Modbus registers and communications specification are designed to work with a PRIMEX Pump Watch™ Express Gateway right out of the box.

- Baud Rate: 9600 baud
- Data Bits: 8 bits
- Stop Bits: 1 bit
- Parity: None
- Node Address: 1
- Modbus Function Codes Supported:
  - Read Holding Registers (0x03)
  - Write Single Register (0x06)
  - Write Multiple Registers (0x10)

Anytime the PC-3000X receives a valid Modbus request, a “Modbus Communication Active” icon (📶) will appear on the Main Screen for 60 seconds. If the Modbus master device is sending a Modbus request more often than once every 60 seconds, the icon will effectively be displayed continuously.

To connect the PC-3000X and the Pump Watch™ Express Gateway, follow the connection diagram below.

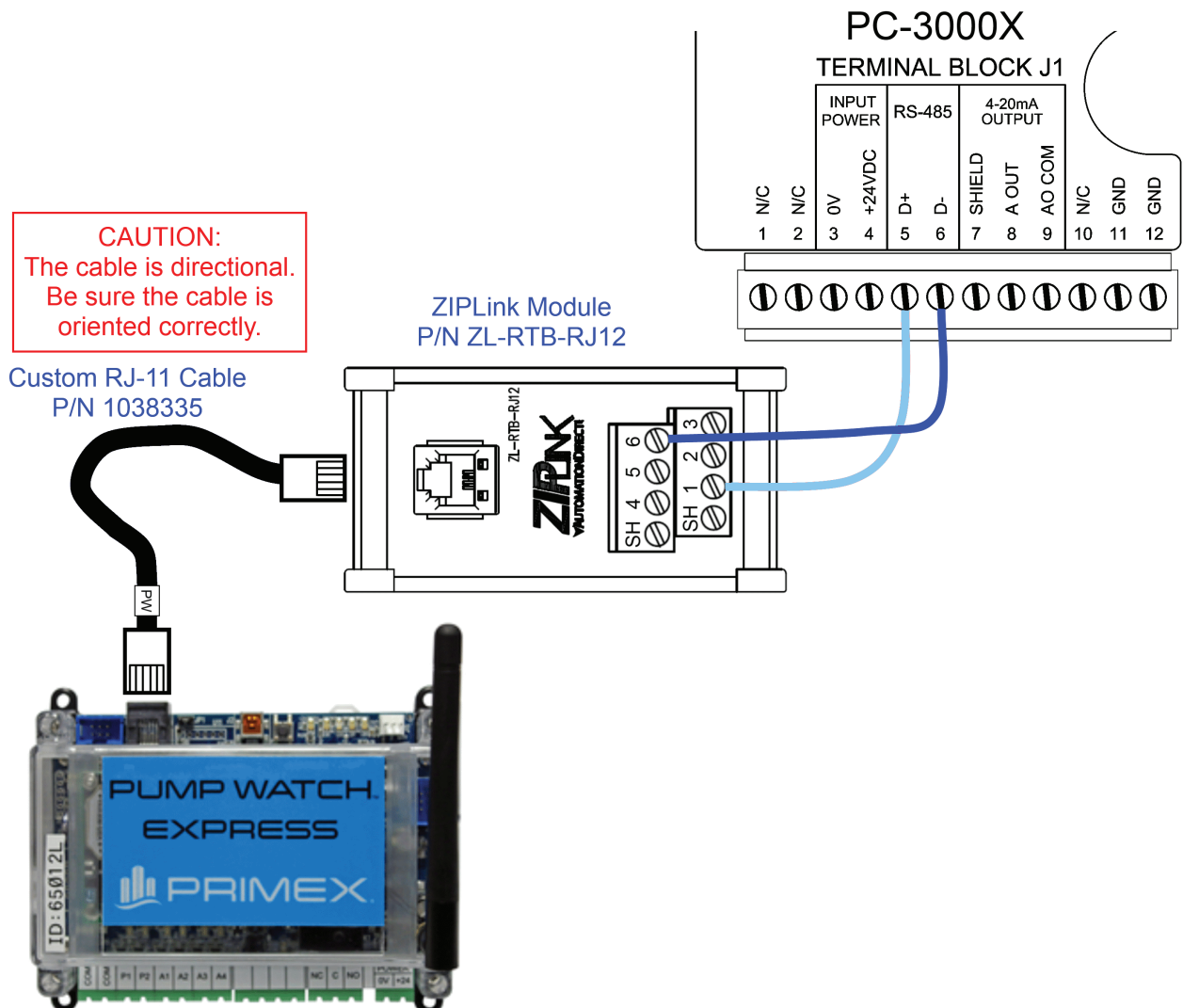

# PC-3000X MODBUS REGISTER LIST

Access Type	Holding Register Number	Bit	Description	Unit of Measure (Other Notes)
Read/Write	42002		Pump Data - HP	
Read/Write	42003		Pump Data - Voltage	
Read/Write	42004		Pump Data - FLA	Tenths of Amps
Read	42005		Station In-flow	GPM (*)
Read	42006		Level	Tenths of Feet
Read	42007		--not used--	
Read	42008		--not used--	
Read	42009		--not used--	
Read	42010		--not used--	
Read	42011		Pump 1 GPM	GPM (*)
Read	42012		Pump 2 GPM	GPM (*)
Read	42013		Pump 3 GPM	GPM (*)
Read	42014		--not used--	
Read	42015		Pump1 Starts/24hrs	(**)
Read	42016		Pump2 Starts/24hrs	(**)
Read	42017		Pump3 Starts/24hrs	(**)
Read	42018		--not used--	
Read	42019		Pump 1 Run Time Per 24 hrs	Minutes (**)
Read	42020		Pump 2 Run Time Per 24 hrs	Minutes (**)
Read	42021		Pump 3 Run Time Per 24 hrs	Minutes (**)
Read	42022		--not used--	
Read	42023		Station Inflow Per 24 hrs	Hundreds of Gallons (**)
Read	42024	0	Pump 1 Running	
		1	Pump 1 Fault	
		2	Pump 1 Auto	(Not Disabled = 1, Pump Disabled = 0)
		3	Pump 2 Running	
		4	Pump 2 Fault	
		5	Pump 2 Auto	(Not Disabled = 1, Pump Disabled = 0)
		6	Pump 3 Running	
		7	Pump 3 Fault	
		8	Pump 3 Auto	(Not Disabled = 1, Pump Disabled = 0)
		9-15	--not used--	
Read	42025	0	--not used--	
		1	Power Fail	
		2	--not used--	
		3	High Level Alarm (Transmitter)	
		4-9	--not used--	
		10	High Level Alarm (Float)	
		11	Low Level Alarm	
		12	Pump Run Time Fault	
		13-15	--not used--	
Read	42026		--not used--	
Read	42027		--not used--	
Read	42028	0	Pump 1 Seal Fail	
		1	Pump 2 Seal Fail	
		2	Pump 3 Seal Fail	
		3-15	--not used--	

\* Holding Register numbers 42011 through 42013 hold the calculated GPM of each pump for that pump's last completed pumping cycle as the lead pump. Likewise, Holding Register 42005 holds the calculated GPM of the station inflow for the most recently completed fill cycle.

\*\* Holding Register numbers 42015 through 42023 hold totals for the most recently completed 24-hour period. A 24-hour period begins at the initial power-on, and ends 24 hours later, at which time the next 24-hour period begins. (When powering off, the controller saves to memory where it was in the 24-hour timing cycle, and then when powered up, the timing picks back up where it left off.)

# PC-3000XC MODBUS (ADVANCED)

The PC-3000XC provides additional Modbus RTU functionality for remote control and monitoring. The Modbus registers and communications parameters can be set in the Modbus Parameters menu. The RS-485 connection is on terminal block J1 terminal 5 D+, and terminal 6 D-.

— Advanced Settings —	
Transmitter Range	15.0 ft
Level Offset	0.0 ft
Number of Pumps	3
Pump ON Delay	5 sec
Pump OFF Delay	5 sec
Setpoint Dwell Time	2 sec
Backup Float Run Time	0 sec
Aux/Dis Input Function	Feedback
Starter Run Feedback Time	2 sec
Seal Fail Polarity	Normal
Temp Fail Reset Mode	Auto-Reset
Aux Relay Function	Horn
Mute/Rst/PwrFail Funct.	Mute/Rst
Max Pumps On At Once	3
Analog Out Low Level	0.0 ft
Analog Out High Level	15.0 ft
Level Units	Feet
Pumping Direction	Down
I/O Status	
Remote Fault Status	
Station Data	
Modbus Parameters	← PC-3000XC Only



— Modbus Parameters —			
Node Address			1
Baud Rate			9600
Pump 1 Remote Run			Active
Pump 2 Remote Run			Inactive
Pump 3 Remote Run			Inactive
Pump 1 Remote Inhibit			Inactive
Pump 2 Remote Inhibit			Inactive
Pump 3 Remote Inhibit			Inactive



— Baud Rate —	
1200	
2400	
4800	
9600	
19,200	
38,400	

- Baud Rate: 1200, 2400, 4800, 9600, 19,200, 38,400 baud
- Node Address: 1-247
- Parity: None (Fixed)
- Stop Bits: 1 (Fixed)
- Data Bits: 8 (Fixed)
- Modbus Function Codes Supported:
  - Read Holding Registers (0x03)
  - Write Single Register (0x06)
  - Write Multiple Registers (0x10)

Anytime the PC-3000XC receives a valid Modbus request, a “Modbus Communication Active” icon (MCA) will appear on the Main Screen for 60 seconds. If the Modbus master device is sending a Modbus request more often than once every 60 seconds, the icon will effectively be displayed continuously.

## REMOTE PUMP RUN OPERATION

When a Remote Pump Run bit is written as a ‘1’, the corresponding pump will turn on and “Remote Pump N Run” will appear at the bottom of the display screen (where N is the number of the pump). The pump will run until this bit is written over as a ‘0’, this bit is cleared locally (see next page), or any pump fault or disable condition occurs, at which time the bit will automatically revert to a ‘0’.

## REMOTE PUMP INHIBIT OPERATION

When a Remote Pump Inhibit bit is written as a ‘1’, the corresponding pump will not be permitted to run and “Remote Pump N Inhibit” will appear at the bottom of the display screen (where N is the number of the pump). The pump will remain inhibited until this bit is written as a ‘0’ or this bit is cleared locally (see next page).



## REMOTE PUMP CONTROL ANNUNCIATION

When a pump is being controlled remotely with either a Remote Pump Run or Remote Pump Inhibit, the Main Screen will display a notification at the bottom of the screen, as in the following example.



## REMOTE PUMP CONTROL STATUS

The status of Remote Pump Run and Remote Pump Inhibit commands for each pump can be viewed in the Modbus Parameters menu.

- **Inactive** - control signal is not currently active.
- **Active** - control signal is active, and the pump is being run/inhibited remotely.
- **N/A** - controller is not configured to use this pump. For example, if Number of Pumps is set to 2, the line items for pump 3 will read N/A.

Modbus Parameters			
Pump 1	Remote Run		Active
Pump 2	Remote Run		Inactive
Pump 3	Remote Run		N/A
Pump 1	Remote Inhibit		Inactive

## REMOTE PUMP CONTROL CLEARING

A Remote Pump Run or Remote Pump Inhibit can be cleared locally by the user through the Modbus Parameters menu. Use the selector wheel to highlight the remote command to clear and press the wheel for ENTER. A confirmation screen will appear. To clear the remote signal, press ENTER again.

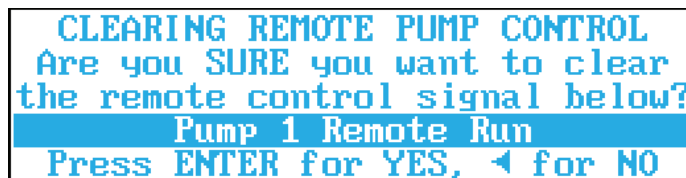

**Note:** If the Remote Pump Run command and Remote Pump Inhibit command are both activated for the same pump, the **Remote Inhibit command will take precedence.**

There are two methods for remotely updating the level setpoints, remote pump control, and other Read/Write registers in this section.

### METHOD ONE - DIRECT WRITE

In the case where the PC-3000XC controller is directly connected to a SCADA or other controller that can update each value with a one-time write, the register can be written to directly. For example, a write to Register Address 42032 will update the Lead Pump ON Setpoint immediately. See the illustration below. Any register write of a value that falls outside the allowable bounds of that register will be ignored, and the register value will not be updated.

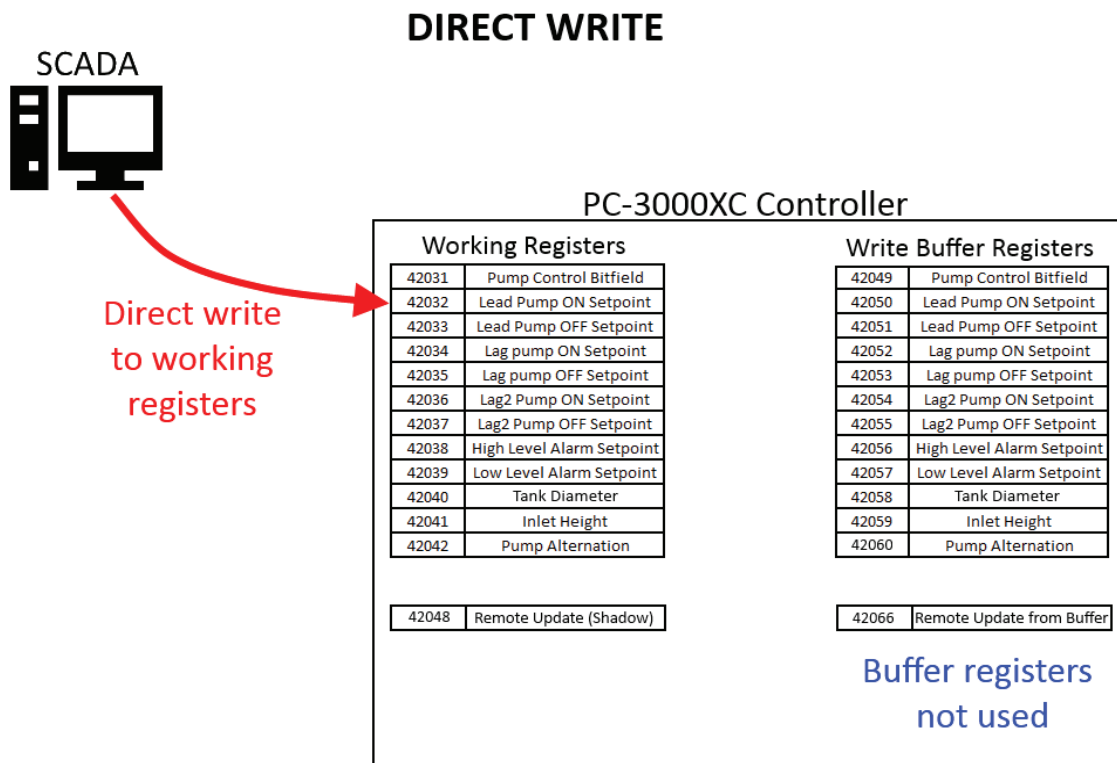

### METHOD TWO - BUFFERED WRITES

In the case where the PC-3000XC is connected to a PLC or telemetry device set to cycle through read and write events continually, the working registers (containing the current value of the parameter the controller is using for operation) should not be written to directly. Instead, updated values should be written to the buffer registers, including the Remote Update register. When no update of the working registers is needed, the Remote Update register is written to as a '0'. If the PLC determines that a register value does need to be updated, the Remote Update register should be written to as a '1' (or any non-zero value). This will cause the value of all working registers to be updated from the buffer registers. See the illustrations on the following page. This determination of when the buffer register values should be updated into the working registers is left completely up to the PLC. The PLC program will be responsible for comparing the current working register values with the desired value to determine if an update is needed, and therefore whether the Remote Update register should be written to as a '0' or a '1'. **NOTE: All write buffer registers need to have a valid value written to them before Remote Update is written to as a '1'; otherwise, unexpected values could be written to the working registers.** The Remote Update shadow register is updated anytime the Remote Update register is written to. This shadow register does not have any function; it is simply there for reading back the value of the Remote Update register as a handshake. The PLC will then be responsible for resetting the Remote Update register to '0'. Also, any direct write to a working register will also write to the corresponding buffer register.

## BUFFERED WRITE - NO UPDATE NEEDED

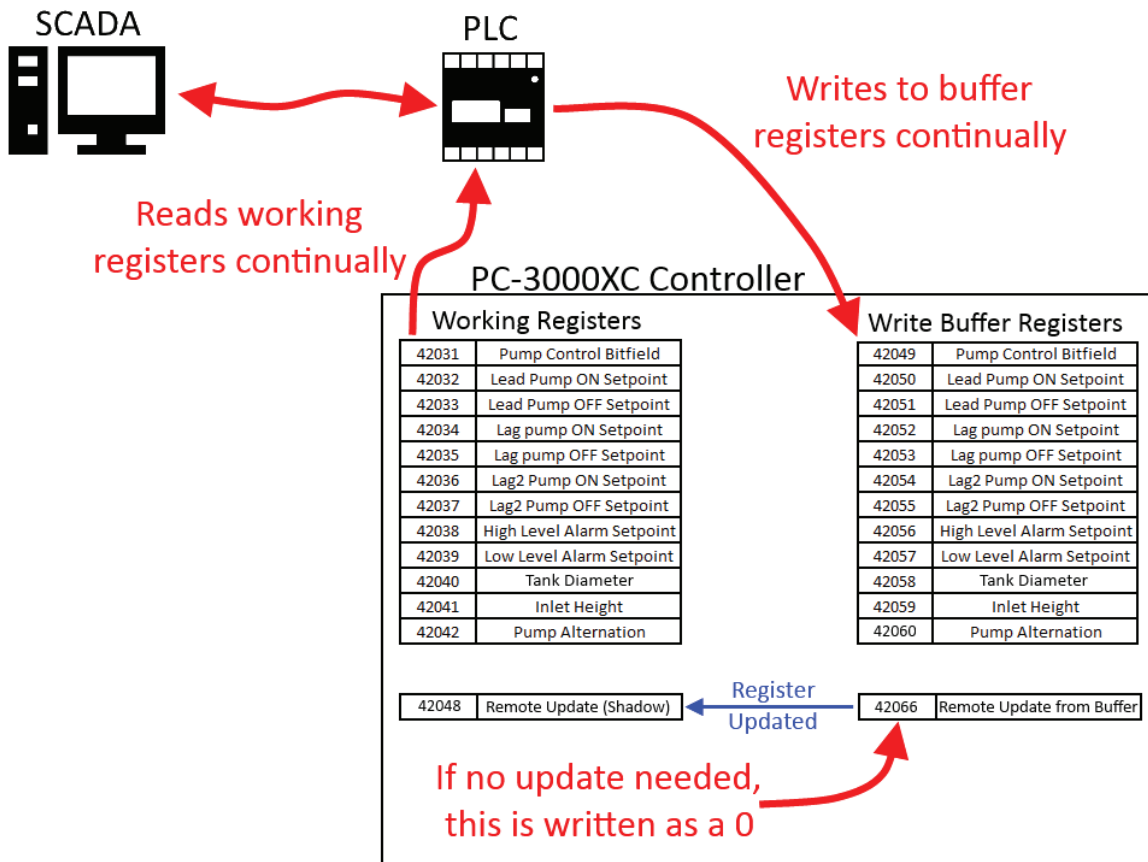

## BUFFERED WRITE - REGISTERS UPDATED

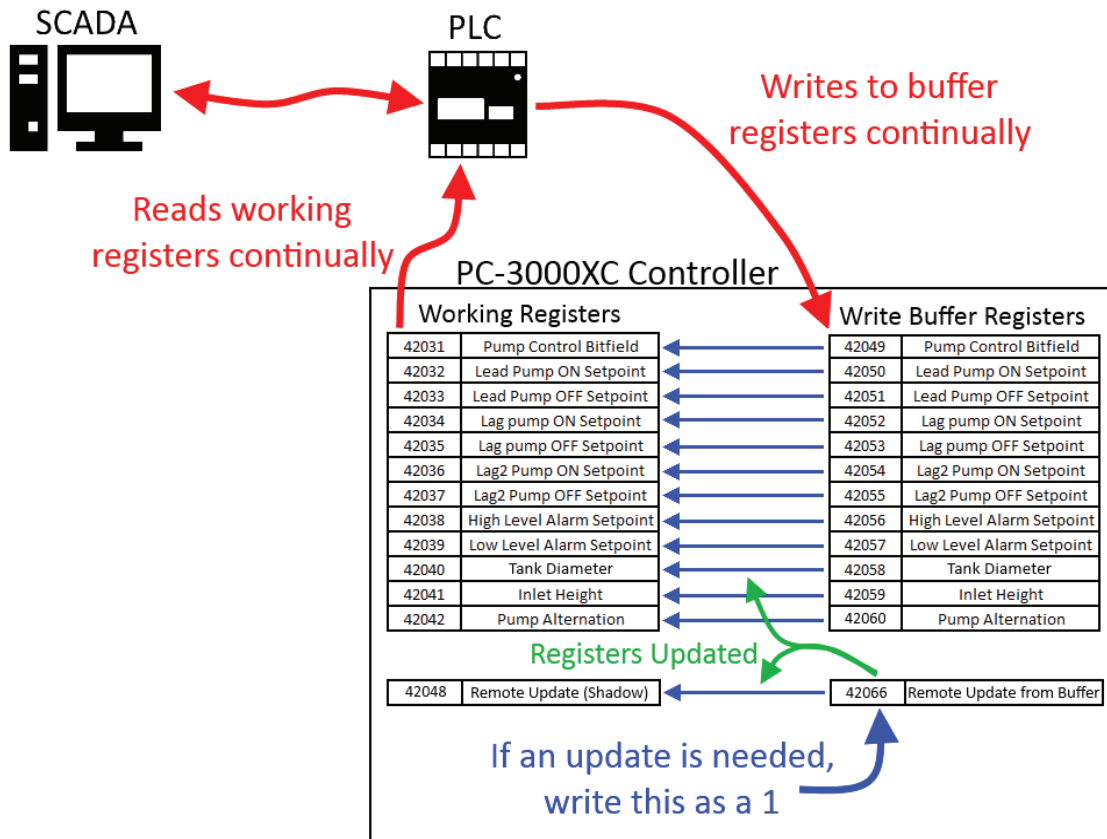

# PC-3000XC MODBUS EXPANDED REGISTER LIST

Combine with PC-3000X on page 21

Access Type	Holding Register Number	Bit	Description	Unit of Measure (Other Notes)
Read	42029		--not used--	
Read	42030		--not used--	
Read/Write	42031	0	Remote Pump Run - Pump 1	Write bit as '1' to run pump remotely Write bit as '0' to stop remote pump run
		1	Remote Pump Run - Pump 2	
		2	Remote Pump Run - Pump 3	
		3-5	--not used--	
		6	Remote Pump Inhibit - Pump 1	Write bit as '1' to inhibit pump remotely Write bit as '0' to stop remote pump inhibit
		7	Remote Pump Inhibit - Pump 2	
		8	Remote Pump Inhibit - Pump 3	
		9-15	--not used--	
Read/Write	42032		Lead Pump ON Setpoint	Tenths of Units
Read/Write	42033		Lead Pump OFF Setpoint	Tenths of Units
Read/Write	42034		Lag pump ON Setpoint	Tenths of Units
Read/Write	42035		Lag pump OFF Setpoint	Tenths of Units
Read/Write	42036		Lag2 Pump ON Setpoint	Tenths of Units
Read/Write	42037		Lag2 Pump OFF Setpoint	Tenths of Units
Read/Write	42038		High Level Alarm Setpoint	Tenths of Units
Read/Write	42039		Low Level Alarm Setpoint	Tenths of Units
Read/Write	42040		Tank diameter	Tenths of Units
Read/Write	42041		Inlet Height	Tenths of Units
Read/Write	42042		Pump Alternation	(Auto=0, Pump 1 Lead =1, Pump 2 Lead =2, Pump 3 Lead =3)
Read/Write	42043		--reserved for future use --	
Read/Write	42044		--reserved for future use --	
Read/Write	42045		--reserved for future use --	
Read/Write	42046		--reserved for future use --	
Read/Write	42047		--reserved for future use --	
Read/Write	42048		Remote Update (Shadow)	Returns the value in the Remote Update register. A write to this register has no effect.
Read/Write	42049	0	BUFFER - Remote Pump Run - Pump 1	(***)
		1	BUFFER - Remote Pump Run - Pump 2	(***)
		2	BUFFER - Remote Pump Run - Pump 3	(***)
		3-5	--not used--	
		6	BUFFER - Remote Pump Inhibit- Pump 1	(***)
		7	BUFFER - Remote Pump Run - Pump 2	(***)
		8	BUFFER - Remote Pump Run - Pump 3	(***)
		9-15	--not used--	
Read/Write	42050		BUFFER - Lead Pump ON Setpoint	Tenths of Units (***)
Read/Write	42051		BUFFER - Lead Pump OFF Setpoint	Tenths of Units (***)
Read/Write	42052		BUFFER - Lag Pump ON Setpoint	Tenths of Units (***)
Read/Write	42053		BUFFER - Lag pump OFF Setpoint	Tenths of Units (***)
Read/Write	42054		BUFFER - Lag2 Pump ON Setpoint	Tenths of Units (***)
Read/Write	42055		BUFFER - Lag2 Pump OFF Setpoint	Tenths of Units (***)
Read/Write	42056		BUFFER - High Level Alarm Setpoint	Tenths of Units (***)
Read/Write	42057		BUFFER - Low Level Alarm Setpoint	Tenths of Units (***)
Read/Write	42058		BUFFER - Tank Diameter	Tenths of Units (***)
Read/Write	42059		BUFFER - Inlet Height	Tenths of Units (***)
Read/Write	42060		BUFFER - Pump Alternation	(Auto=0, Pump 1 Lead=1, Pump 2 Lead = 2, Pump 3 Lead =3 (***)
Read/Write	42061		BUFFER -- reserved for future use --	(***)
Read/Write	42062		BUFFER -- reserved for future use --	(***)
Read/Write	42063		BUFFER -- reserved for future use --	(***)
Read/Write	42064		BUFFER -- reserved for future use --	(***)
Read/Write	42065		BUFFER -- reserved for future use --	(***)
Read/Write	42066		Remote Update	Write as a '1' to move all buffer values into working registers
Read	42067		Level	Tenths of Units (not converted to feet)

# PC-3000XC MODBUS EXPANDED REGISTER LIST

Continued

Access Type	Holding Register Number	Bit	Description	Unit of Measure (Other Notes)
Read	42068		Pump1 ETM	Hours
Read	42069		Pump2 ETM	Hours
Read	42070		Pump3 ETM	Hours
Read	42071		Pump 1 Cycles (Low)	(32-bit Value)
Read	42072		Pump 1 Cycles (High)	
Read	42073		Pump 2 Cycles (Low)	(32-bit Value)
Read	42074		Pump 2 Cycles (High)	
Read	42075		Pump 3 Cycles (Low)	(32-bit Value)
Read	42076		Pump 3 Cycles (High)	
Read	42077		High Level Alarm Count	
Read	42078		Low Level Alarm Count	
Read	42079		Backup Float Count	

\*\*\* These read-only BUFFER registers can be written to at any time, but do not affect the operation of the controller until the Remote Update register is written as any non-zero value.

# MOUNTING DIMENSIONS

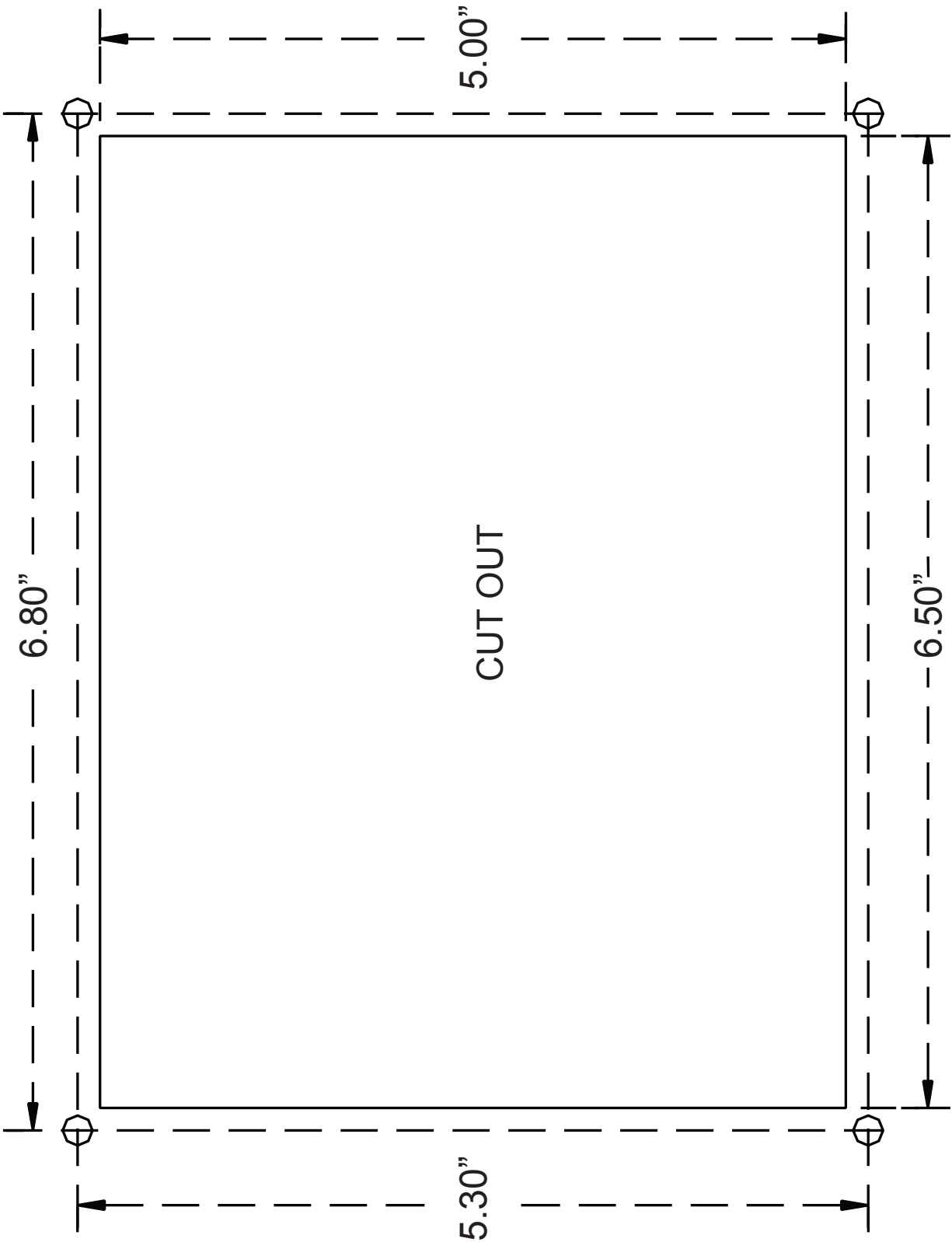

**Not to scale. Do not use as a template.**

# CONTROLLER DIMENSIONS

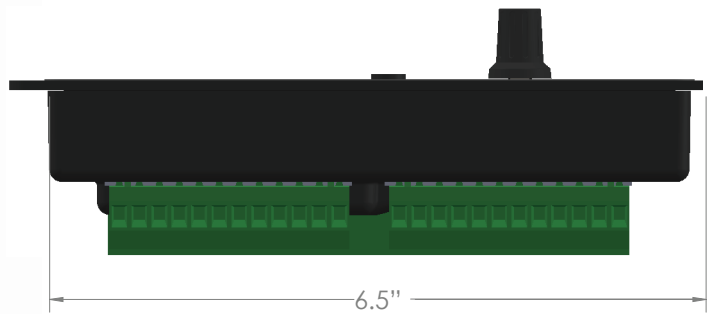
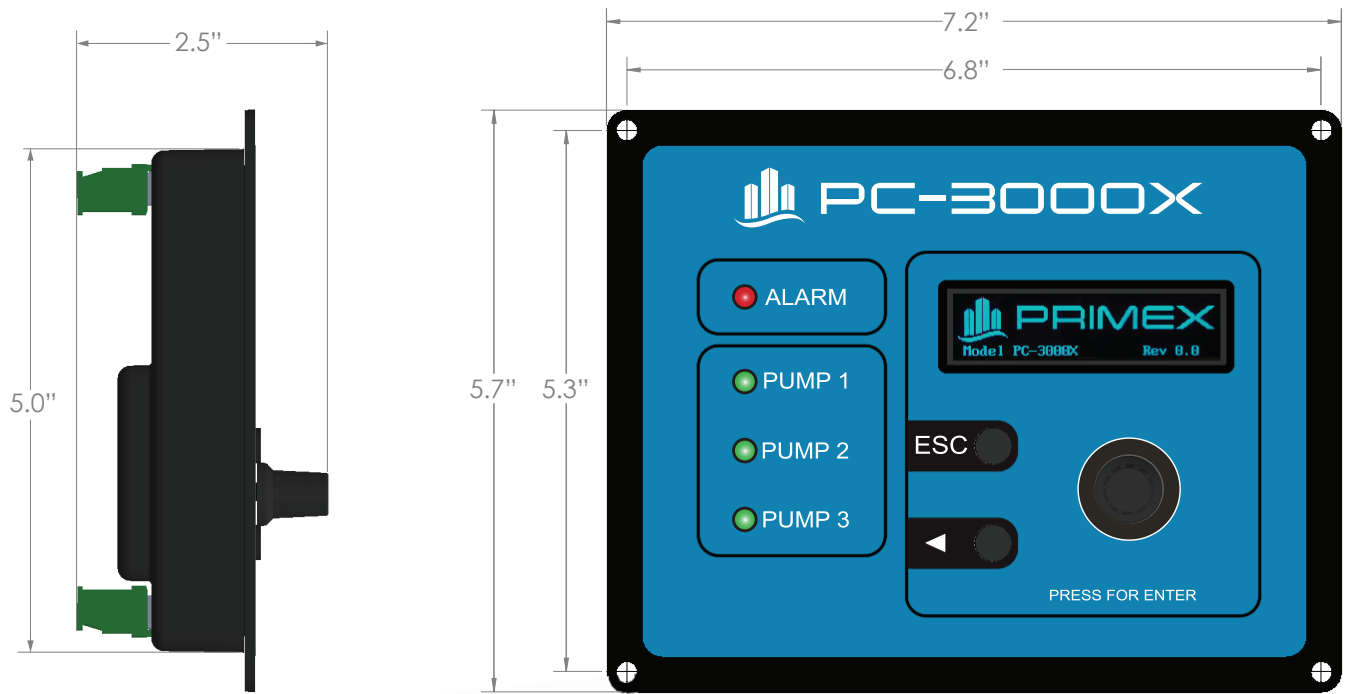

**Note: PC-3000X and PC-3000XC have the same dimensions.**

# RETROFIT REPLACEMENT OF A PC-3000

The PC-3000X or PC-3000XC can be installed in place of a previously installed legacy PRIMEX PC-3000 controller. The steps to follow to do this are:

1. Carefully note all user settings on the PC-3000 before removal so the same settings can be entered on the PC-3000X or PC-3000XC after installation.
2. Switch off all power sources to the PC-3000 controller.
3. Unplug the three green pluggable terminal blocks from the back of the PC-3000. Carefully note which 12-position terminal block is plugged into which socket on the PC-3000 (J1 on the left, J2 on the right); you will need to be sure to plug them back in on the same locations on the PC-3000X or PC-3000XC.
4. Remove the four corner mounting screws that secure the PC-3000 housing to the subdoor.
5. Remove the PC-3000 from the subdoor cutout, and insert the PC-3000X or PC-3000XC in its place.
6. Secure the PC-3000X or PC-3000XC housing to the subdoor using the four corner screws you previously had removed from the PC-3000.
7. Plug the three green pluggable terminal blocks into the PC-3000X or PC-3000XC controller. Be sure the two 12-position terminal blocks are plugged into the correct locations, as noted earlier.
8. If the control panel does not already contain a Class 2 24VDC power supply, install one in the control panel. Connect the power supply's 0VDC signal to terminal J1-3, and the +24VDC signal to terminal J1-4. You can remove the 120VAC power wires from the J1-1 and J1-2 terminals if you like, or you can leave them there. Those terminals on the PC-3000X are non-functional, but are designed to accept the 120VAC from the legacy-PC-3000 supply power without damage.

(Continued on next page.)



9. Switch power on and go through the menus, assigning settings according to the PC-3000 settings you noted earlier. The corresponding settings between the two controllers are listed below:

PC-3000	PC-3000X/PC-3000XC
ALTERNATE	Alternation
LEAD ON	Lead Pump ON
LEAD OFF	Lead Pump OFF
LAG ON	Lag Pump ON
LAG OFF	Lag Pump OFF
LAG2 ON	Lag2 Pump ON
LAG2 OFF	Lag2 Pump OFF
HI ALARM	High Level Alarm
LO ALARM	Low Level Alarm
MAX LEVEL	Transmitter Range
OFFSET	Level Offset
HOW MANY PUMPS	Number Of Pumps
START DELAY	Pump ON Delay
STOP DELAY	Pump OFF Delay
TIME AT SP	Setpoint Dwell Time

PC-3000	PC-3000X/PC-3000XC
HIGH LATCH	N/A
BACKUP TIME	Backup Float Run Time
START TEST	Aux/Dis Input Function
	Starter Run Feedback Time
SEAL	Seal Fail Polarity
TEMP	Temp Fail Reset Mode
AUX R	Aux Relay Function
MAX ON AT ONCE	Max Pumps On At Once
A OUT LOW	Analog Out Low Level
A OUT HI	Analog Out High Level
N/A	Level Units
PUMP UP/DOWN	Pumping Direction
N/A	Pump Horsepower
N/A	Pump Voltage
N/A	Pump FLA
N/A	Tank Diameter

10. Test the controller operation to be sure it works in your application.

# ELECTRICAL WIRING DIAGRAM

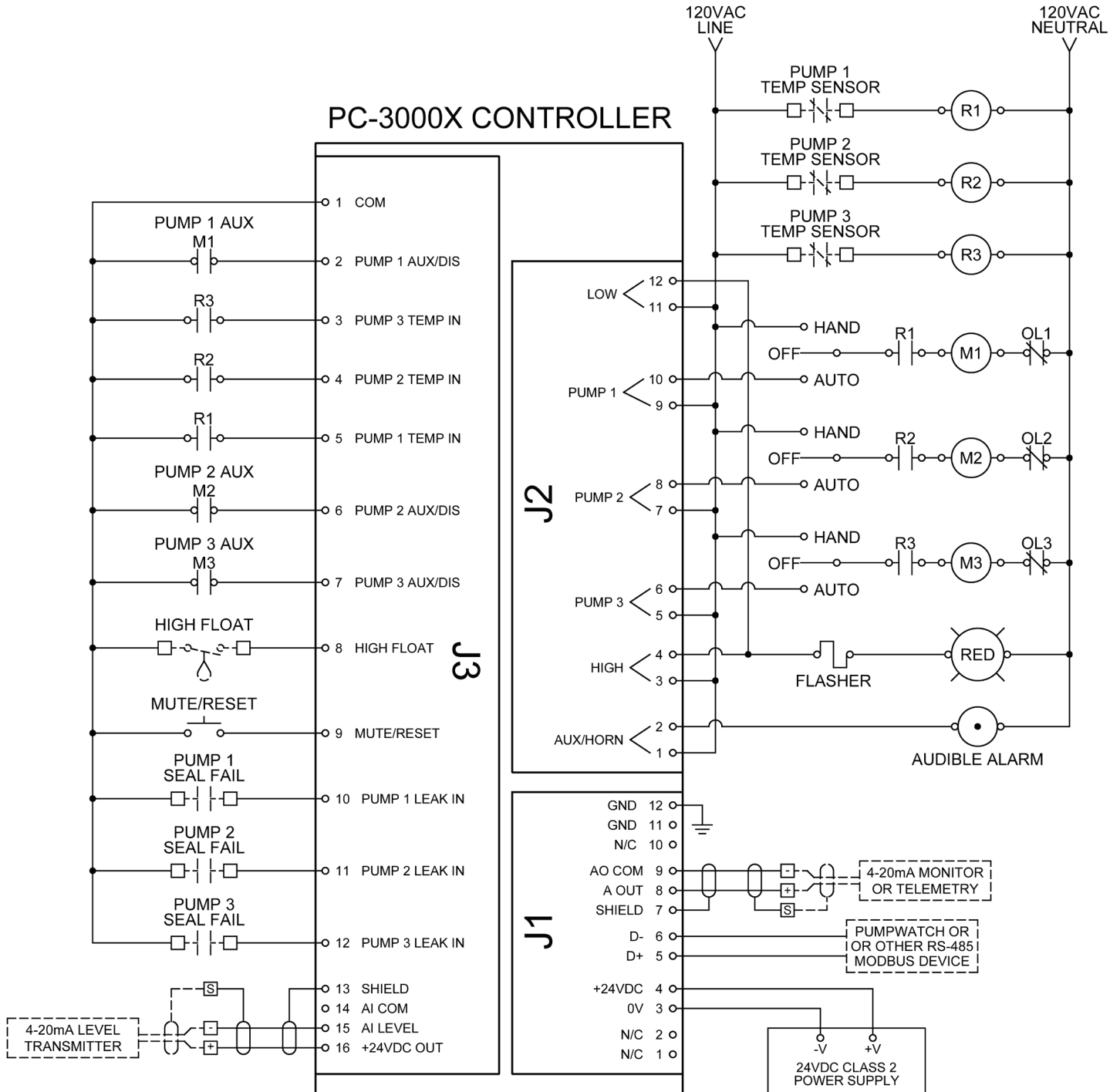

# CONTROLLER SETPOINTS LIST

STATION NAME:					
START UP DATE:					
CONTROLLER REV:					
	MIN	MAX	DEFAULT VALUE	USER SETTING	
<b>LEVEL SETPOINTS</b>					
Lead Pump ON	0	999.9	<b>7.0</b>		
Lead Pump OFF	0	999.9	<b>4.0</b>		
Lag Pump ON	0	999.9	<b>8.0</b>		
Lag Pump OFF	0	999.9	<b>4.0</b>		
Lag2 Pump ON	0	999.9	<b>9.0</b>		
Lag2 Pump OFF	0	999.9	<b>4.0</b>		
High Level Alarm	0	999.9	<b>10.0</b>		
Low Level Alarm	0	999.9	<b>3.0</b>		
<b>ADVANCED SETTINGS</b>					
Transmitter Range	1.0	999.9	<b>15.0</b>		
Level Offset	0	999.9	<b>1.0</b>		
Number Of Pumps	1	3	<b>2</b>		
Pump ON Delay	0	250	<b>5 sec</b>		
Pump OFF Delay	0	250	<b>5 sec</b>		
Setpoint Dwell Time	0	99	<b>2 sec</b>		
Backup Float Run Time	0	999	<b>0 sec</b>		
Aux/Dis Input Function	List		<b>Feedback</b>		
Starter Run Feedback Time	1	99	<b>2 sec</b>		
Seal Fail Polarity	List		<b>Normal</b>		
Temp Fail Reset Mode	List		<b>Auto-Reset</b>		
Aux Relay Function	List		<b>Horn</b>		
Mute/Rst/PwrFail Function	List		<b>Mute/Reset</b>		
Max Pumps On At Once	1	3	<b>2</b>		
Analog Out Low Level	0	999.9	<b>0.0</b>		
Analog Out High Level	0	999.9	<b>16.0</b>		
Level Units	List		<b>Feet</b>		
Pumping Direction	List		<b>Down</b>		
<b>REMOTE FAULT STATUS</b>					
Power Fail Delay Time	0	999	<b>20</b>		
Max. Pump Run Time	0	99.9	<b>0.0</b>		
<b>STATION DATA</b>					
Pump Horsepower	0	999	<b>10</b>		
Pump Voltage	0	999	<b>460</b>		
Pump FLA	0	999.9	<b>15.0</b>		
Tank Diameter	0	999.9	<b>6.0</b>		
Inlet Height	0	999.9	<b>0.0</b>		
<b>MODBUS PARAMETERS (PC-3000XC only)</b>					
Node Address	1	247	<b>1</b>		
Baud Rate	List		<b>9600</b>		



+1-844-4PRIMEX (477-4639)  
WWW.PRIMEXCONTROLS.COM

PN 1046786H 10/20  
© 2020 SJE, Inc. All Rights Reserved.  
PRIMEX is a trademark of SJE, Inc.